

Iso-Mix 100 TUS

Sound-insulated inline mixed-flow fans



- Maximum airflow: 233
- Sound pressure level LpA at 3 m: 29
- Sound insulation
- Motor type: AC
- Control: Built-in speed controller
- Impeller type: Mixed-flow
- Casing material: Coated steel
- Installation in any position
- Timer: Turn off timer

	Unit of measurement	Iso-Mix 100 TUS	
Connected air duct size	mm	100	
Speed	-	2	
Phases	-	1	
Minimum supply voltage	V	230	
Maximum supply voltage	V	230	
Power supply frequency	Hz	50/60	
Rated power	W	24	26
Unit current	A	0.1	0.11
Maximum airflow	m ³ /h	175	233
rotation speed at 50hz	-	2015	2610
Sound pressure level LpA at 3 m	dB(A)	24	29
Weight	kg	4.6	
Transported air temperature (max)	°C	60	
Ingress protection rating	-	IPX4	
Ingress protection rating of the drive	-	IP44	

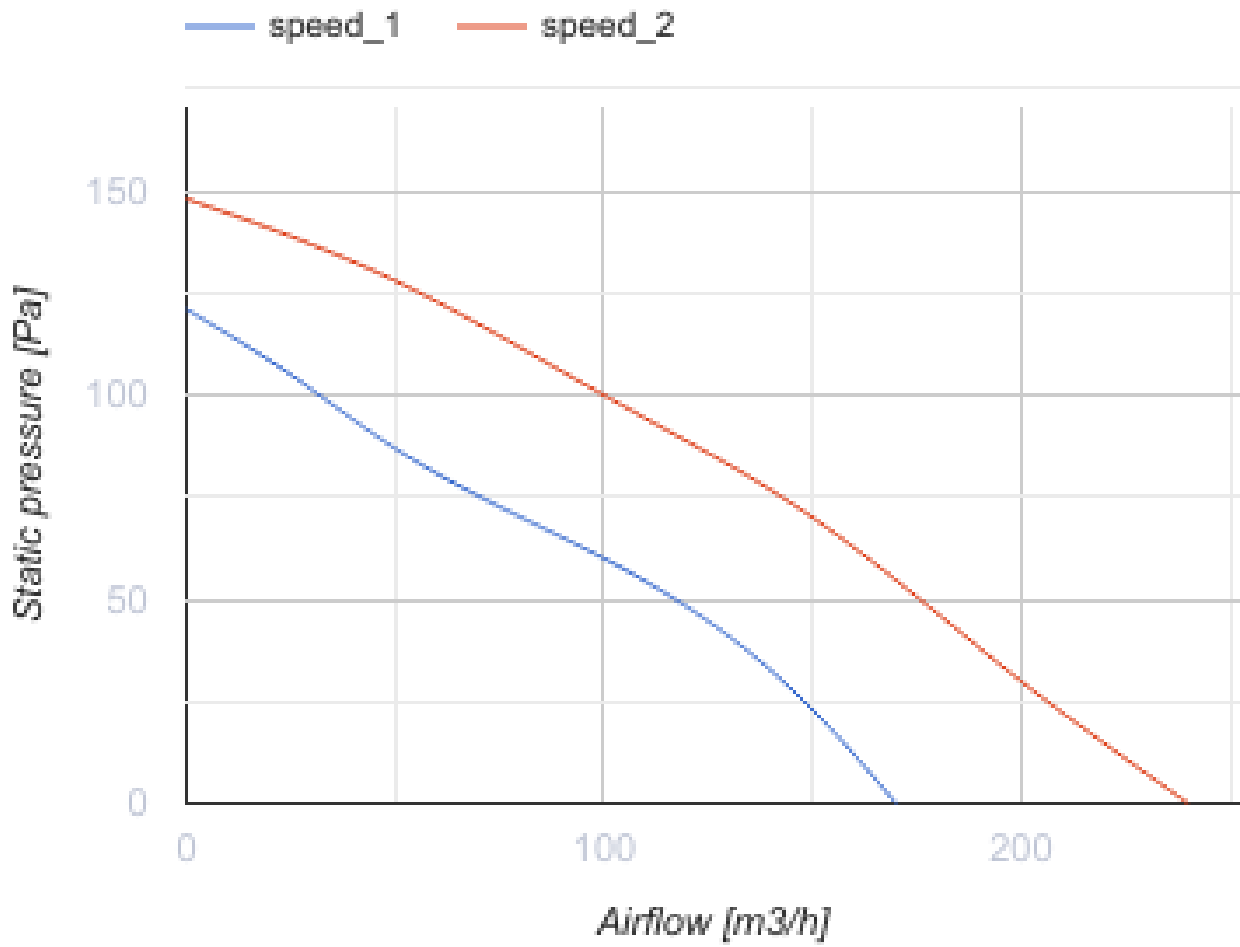

Dimensions

ØD	B	B1	L	H
98	214	243	505	251

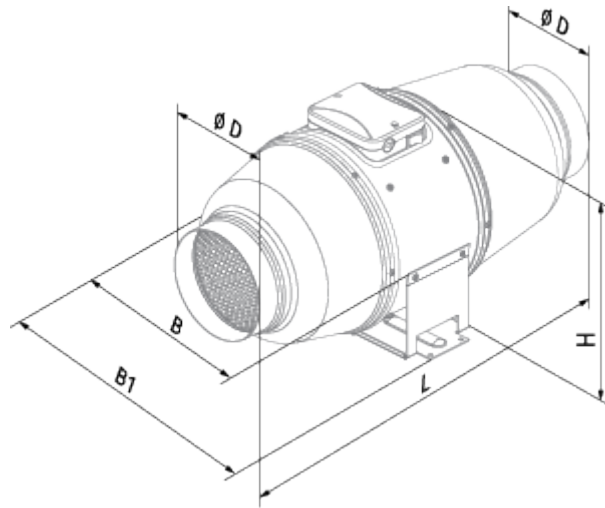



Ecodesign



Trademark	Blauberg					
Model	Iso-Mix 100 TUS					
Specific energy consumption (SEC) (kWh/(m ² /a))	Cold		Average		Warm	
	49	A+	21.9	D	6.4	F
Type of ventilation unit	Unidirectional					
Type of drive installed	Multi-speed					
Type of heat recovery system	None					
Maximum flow rate (m ³ /h)	100					
Electric power input (W)	26					
Reference flow rate (m ³ /s)	0.019					
Reference pressure difference (Pa)	50					
Specific power input (SPI) (W/(m ³ /h))	0.343					
Control typology	Local demand control					
Maximum external leakage rates (%)	2.7					
Sound power level (dB(A))	29					
Declared typology	RVU UVU					
The annual electricity consumption (AEC) (kWh/a)	Cold		Average		Warm	
	256		256		256	
The annual heating saved (AHS) (kWh/a)	Cold		Average		Warm	
	5536		2830		1280	

Accessories

Speed control switches





Name	Photo	Description
CDP-2/5		Multi-speed switch
CDP-2/10		Multi-speed switch

Thyristor speed controllers





Name	Photo	Description
------	-------	-------------

CDT E1.8		Thyristor speed controller
CDT1 E0.5		Multi-speed switches

Humidity sensors





Name	Photo	Description
TE / TI 1.5		Timers
HSE / HSI 1.5		Sensors
LSE / LSI 1.5		Sensors
IRSE / IRSI 1.5		Sensors

Electrical heaters



Name	Photo	Description
EKH 100-0.8		Duct electrical heaters for round ducts
EKH 100-0.6		Duct electrical heaters for round ducts
EKH 100-1.2		Duct electrical heaters for round ducts
EKH 100-1.6		Duct electrical heaters for round ducts
EKH 100-1.8		Duct electrical heaters for round ducts

For round ducts



Name	Photo	Description
------	-------	-------------

KFBT 100 F7		Filter boxes with pocket filters for round ducts
KFBT 100 F5		Filter boxes with pocket filters for round ducts
KFBT 100 G4		Filter boxes with pocket filters for round ducts
KFBK 100		Filter boxes for round ducts

For round ducts

Name	Photo	Description
SD 100/1200		Silencers for round ducts
SD 100/900		Silencers for round ducts
SD 100/600		Silencers for round ducts

Water heaters

Name	Photo	Description
WKH 100-2		Duct water heaters for round ducts
WKH 100-4		Duct water heaters for round ducts

For round ducts

Name	Photo	Description
VRV 100		Backdraft dampers with spring for round ducts
VKA 100		Air dampers for round ducts