



Iso-K 200 4E

Sound-insulated inline fans

- Maximum airflow: 1600
- Sound pressure level LpA at 3 m: 45
- Sound insulation
- Motor type: AC
- Impeller type: Centrifugal forward curved blades
- Casing material: Galvanized steel

	Unit of measurement	Iso-K 200 4E
Connected air duct size	mm	200
Speed	-	1
Minimum supply voltage	V	230
Maximum supply voltage	V	230
Power supply frequency	Hz	50
Rated power	W	550
Unit current	A	3
Maximum airflow	m ³ /h	1600
Sound pressure level LpA at 3 m	dB(A)	45
Weight	kg	25
Transported air temperature (max)	°C	120
Transported air temperature (min)	°C	-20
Ingress protection rating	-	IP54

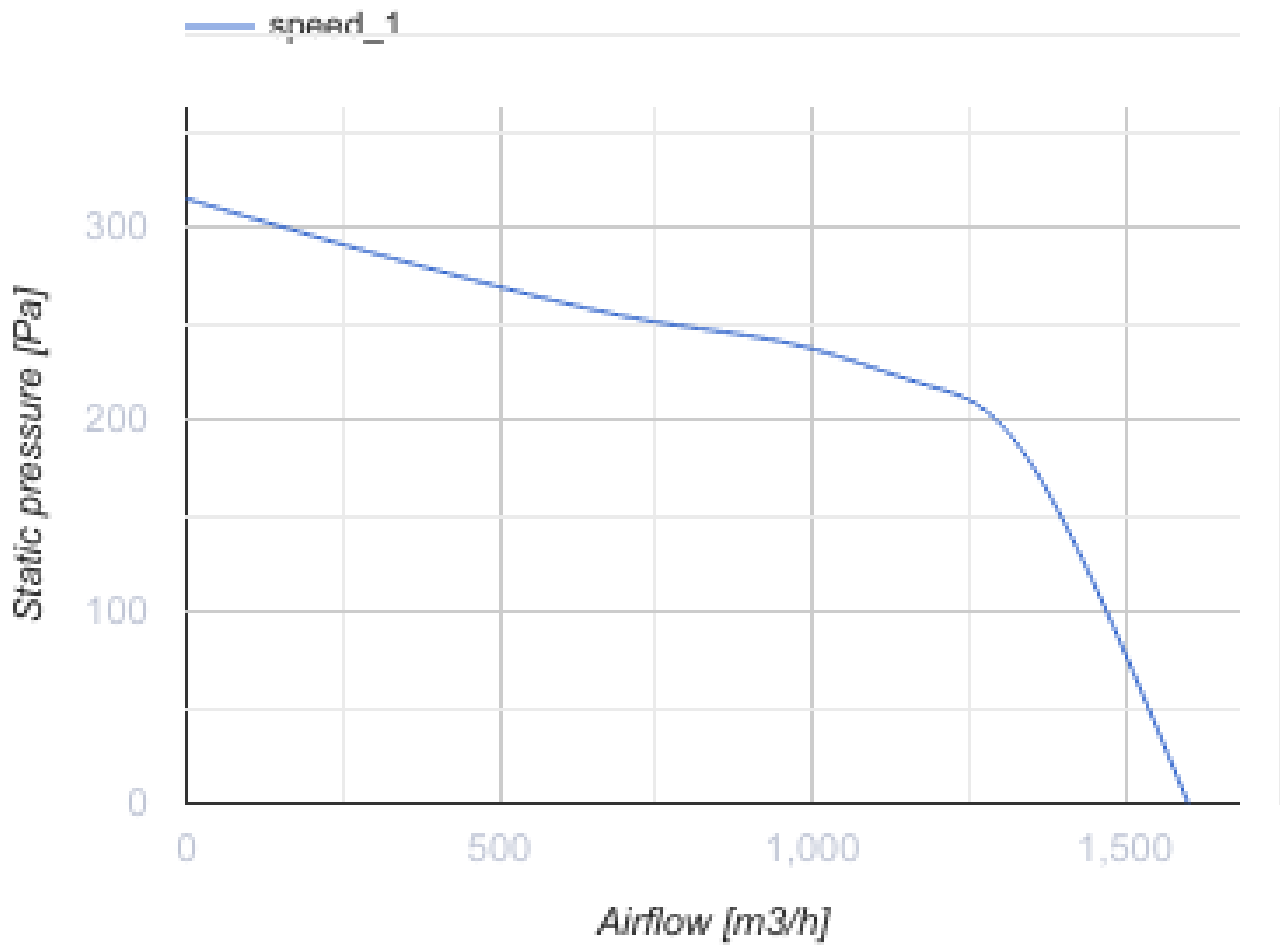

Dimensions

Ø D	B	B1	H	H1	L	L1	L2	L3	L4
200	485	365	600	425	625	600	570	515	235





Ecodesign

Trademark	Blauberg
Model	Iso-K 200 4E
Type of ventilation unit	Unidirectional
Type of drive installed	External MSD or VSD
Type of heat recovery system	None
Nominal flow rate (m ³ /s)	0.242
Nominal external pressure (Pa)	250
Maximum external leakage rates (%)	2.7
Static efficiency (%)	17.8
Declared typology	NRVU UVU
Sound power level (dB(A))	65
Effective electric power input (kW)	0.347