

Iso Box-F 150 G4/F8/Carbon

Sound-insulated inline centrifugal fans with filters



- Maximum airflow: 440
- Sound pressure level LpA at 3 m: 27
- Sound insulation
- Motor type: AC
- Impeller type: Centrifugal impeller with backward curved blades
- Casing material: Coated steel
- Installation in any position

	Unit of measurement	Iso Box-F 150 G4/F8/Carbon
Connected air duct size	mm	150
Speed	-	1
Phases	-	1
Minimum supply voltage	V	230
Maximum supply voltage	V	230
Power supply frequency	Hz	50
Rated power	W	107
Unit current	A	0.49
Maximum airflow	m ³ /h	440
Sound pressure level LpA at 3 m	dB(A)	27
Weight	kg	0
Transported air temperature (max)	°C	40
Transported air temperature (min)	°C	-25
Ingress protection rating	-	IPX4
Ingress protection rating of the drive	-	IP44

Dimensions

Ø D	L	H	B	L1	B1	L2	B2
150	735	300	440	835	533	680	483

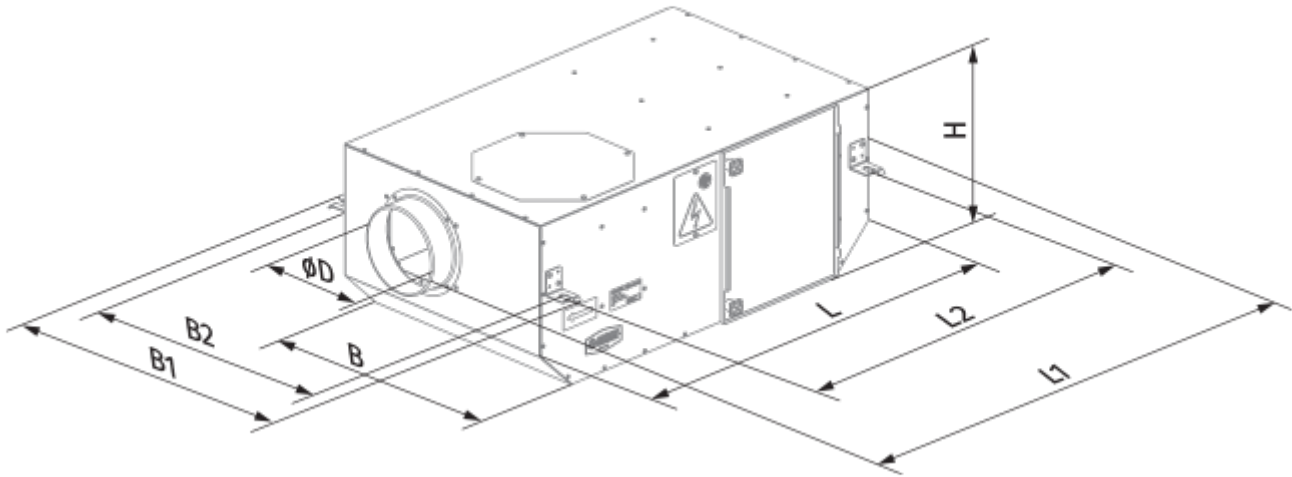

Accessories

Thyristor speed controllers

Name	Photo	Description
CDT E1.8		Thyristor speed controller

Speed control switches

Name	Photo	Description
CDP-2/10		Multi-speed switch