

# Iso Box-F 100 G4/Carbon V2

Sound-insulated inline centrifugal fans with filters

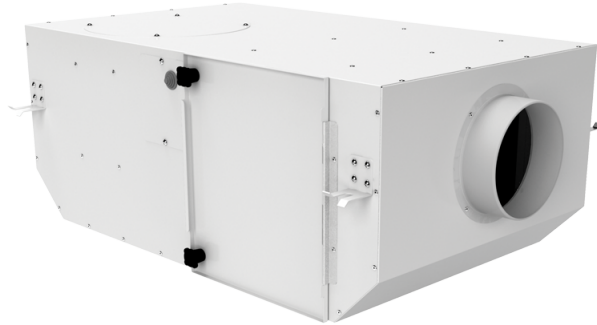

- Maximum airflow: 190
- Sound pressure level LpA at 3 m: 23
- Sound insulation
- Motor type: AC
- Impeller type: Centrifugal impeller with backward curved blades
- Casing material: Coated steel
- Installation in any position

	Unit of measurement	Iso Box-F 100 G4/Carbon V2	
Connected air duct size	mm	100	
Speed	-	2	
Minimum supply voltage	V	230	
Maximum supply voltage	V	230	
Power supply frequency	Hz	50	
Rated power	W	34	42
Unit current	A	0.15	0.19
Maximum airflow	m <sup>3</sup> /h	160	190
Sound pressure level LpA at 3 m	dB(A)	14	23
Weight	kg	0	
Transported air temperature (max)	°C	40	
Transported air temperature (min)	°C	-25	
Ingress protection rating	-	IPX4	
Ingress protection rating of the drive	-	IP44	

## Dimensions

ØD	L	H	B	L1	B1	L2	B2
100	705	250	415	805	508	650	458



## Ecodesign

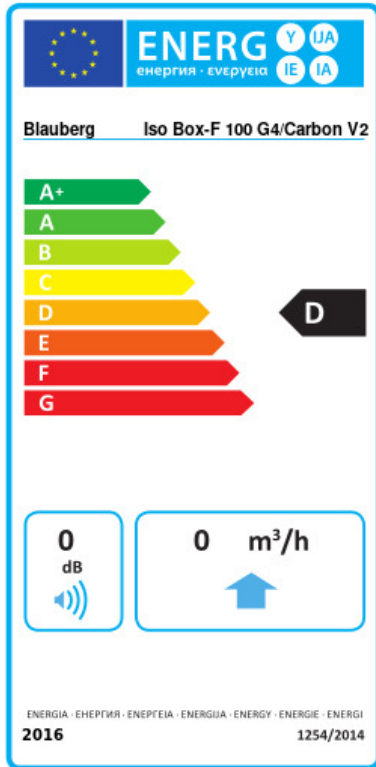

Trademark	Blaubeerg					
Model	Iso Box-F 100 G4/Carbon V2					
Specific energy consumption (SEC) (kWh/(m <sup>2</sup> /a))	Cold		Average		Warm	
	0	A+	0	D	0	F
Type of ventilation unit	Unidirectional					
Type of drive installed	2-speed					
Type of heat recovery system	None					
Maximum flow rate (m <sup>3</sup> /h)	0					
Electric power input (W)	0					
Reference flow rate (m <sup>3</sup> /s)	0					
Reference pressure difference (Pa)	0					
Specific power input (SPI) (W/(m <sup>3</sup> /h))	0					
Control typology	Local demand control					
Maximum external leakage rates (%)	0					
Declared typology	RVU UVU					
Sound power level (dB(A))	0					
The annual electricity consumption (AEC) (kWh/a)	Cold		Average		Warm	
	0		0		0	
The annual heating saved (AHS) (kWh/a)	Cold		Average		Warm	
	0		0		0	

## Accessories

### Thyristor speed controllers

Name	Photo	Description
<a href="#">CDT E1.8</a>		Thyristor speed controller

### Speed control switches

Name	Photo	Description
------	-------	-------------

[CDP-2/10](#)



Multi-speed switch