

Iso-B 250

Sound-insulated inline centrifugal fans



- Maximum airflow: 1300
- Sound pressure level LpA at 3 m: 41
- Sound insulation
- Motor type: AC
- Impeller type: Centrifugal backward curved blades
- Casing material: Galvanized steel
- Installation in any position

	Unit of measurement	Iso-B 250
Connected air duct size	mm	250
Speed	-	1
Minimum supply voltage	V	220
Maximum supply voltage	V	240
Power supply frequency	Hz	50/60
Rated power	W	198
Unit current	A	0.87
Maximum airflow	m ³ /h	1300
Sound pressure level LpA at 3 m	dB(A)	41
Weight	kg	12.5
Transported air temperature (max)	°C	50
Transported air temperature (min)	°C	-25
Ingress protection rating	-	IPX4

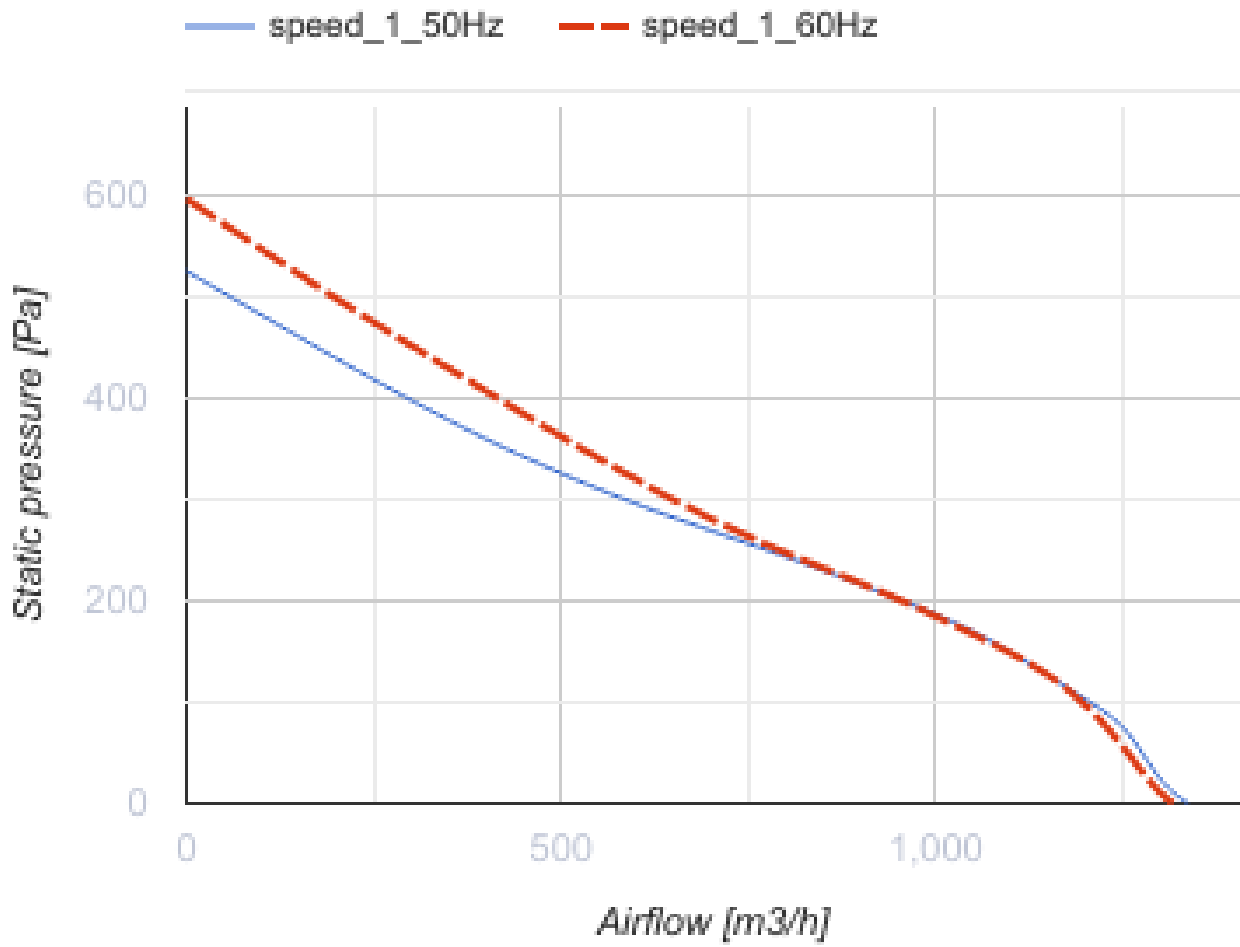

Dimensions

D	B	B1	H	L	L1	L2
249	432	368	287	588	506	480

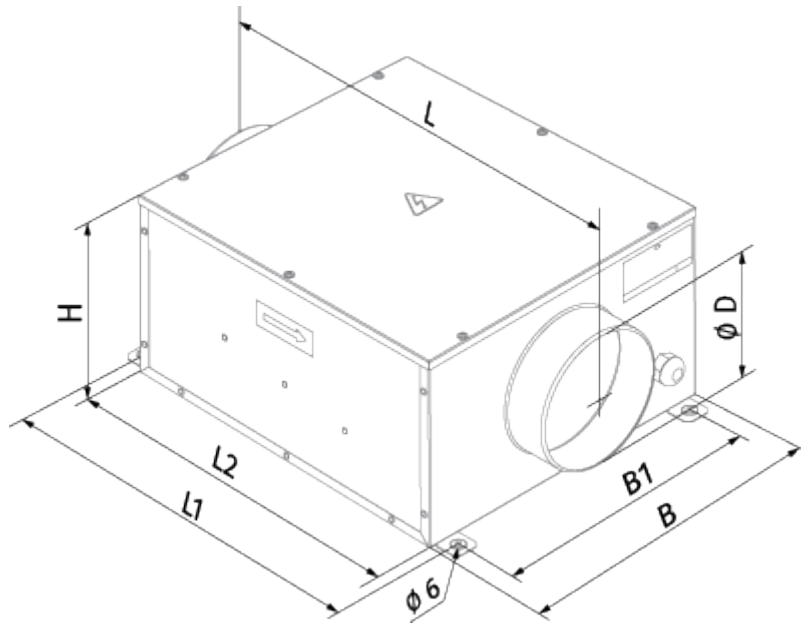

Ecodesign



Trademark	Blauberg
Model	Iso-B 250
Type of ventilation unit	Unidirectional
Type of drive installed	External MSD or VSD
Type of heat recovery system	None
Nominal flow rate (m ³ /s)	0.205
Nominal external pressure (Pa)	258
Maximum external leakage rates (%)	2.7
Static efficiency (%)	27.5
Declared typology	NRVU UVU
Sound power level (dB(A))	61
Effective electric power input (kW)	0.196

Accessories

Thyristor speed controllers

Name	Photo	Description
CDT E1.8		Thyristor speed controller

Humidity sensors

Name	Photo	Description
TE / TI 1.5		Timers
HSE / HSI 1.5		Sensors
LSE / LSI 1.5		Sensors

[IRSE / IRSI 1.5](#)



Sensors