

# inWave EC 150/160 FR1

Sound-insulated inline mixed-flow fans with EC motor

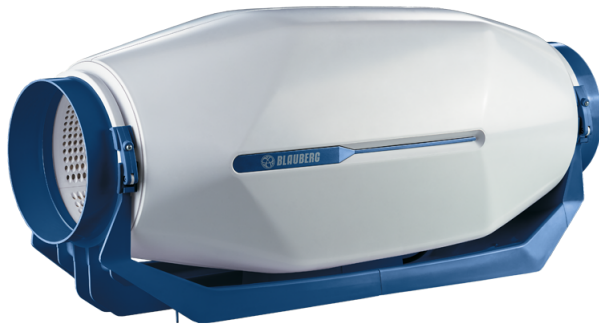

- Maximum airflow: 600
- Sound pressure level LpA at 3 m: 38
- Sound insulation
- Motor type: EC
- Control: Speed controller
- Impeller type: Mixed-flow
- Casing material: Plastic
- Cable with mains plug

	Unit of measurement	inWave EC 150/160 FR1
Connected air duct size	mm	160/150
Phases	-	1
Minimum supply voltage	V	230
Maximum supply voltage	V	230
Power supply frequency	Hz	50/60
Rated power	W	55
Unit current	A	0.49
Maximum airflow	m <sup>3</sup> /h	600
rotation speed at 50hz	-	3506
Sound pressure level LpA at 3 m	dB(A)	38
Weight	kg	5
Transported air temperature (max)	°C	55
Transported air temperature (min)	°C	-25
Ambient air temperature min	°C	1
Ambient air temperature max	°C	40
Ingress protection rating	-	IPX4
Ingress protection rating of the drive	-	IP44

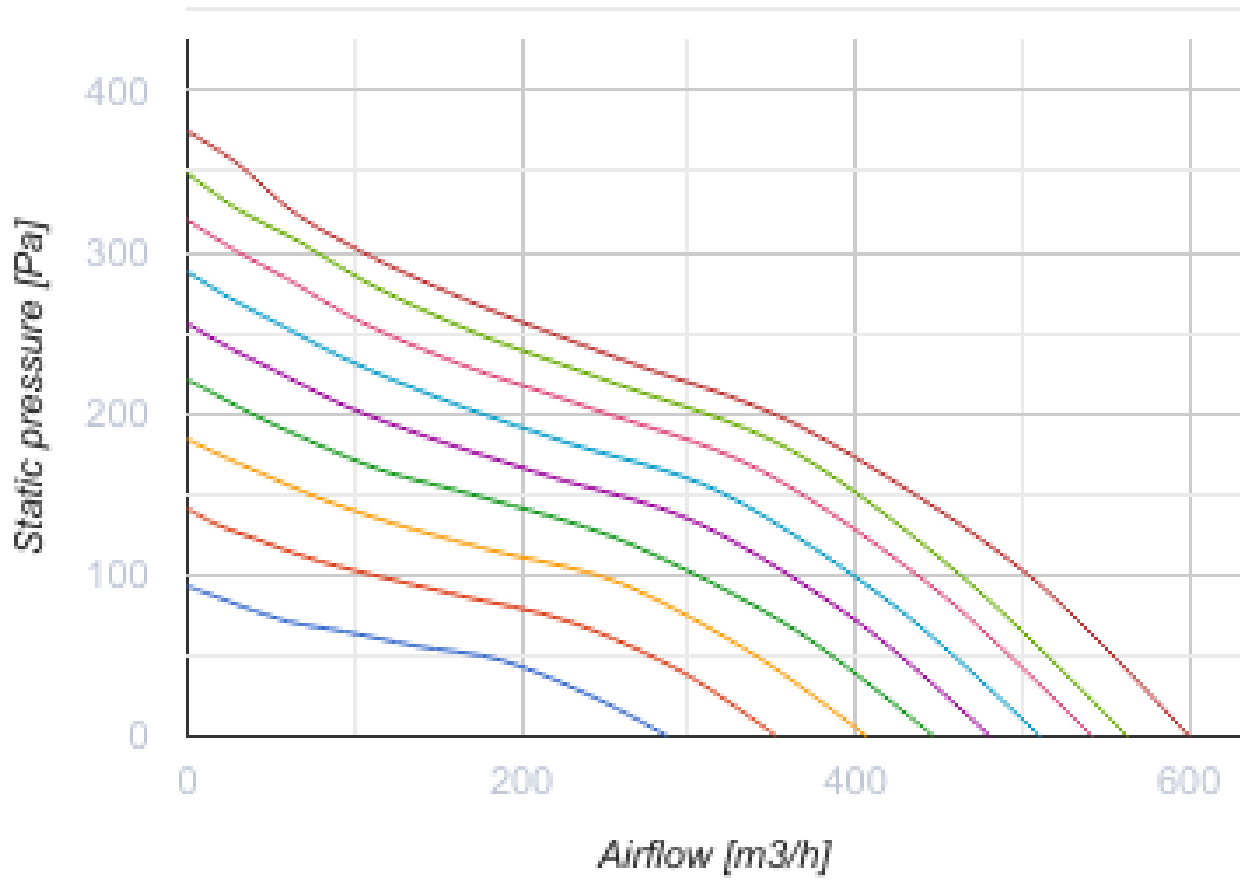

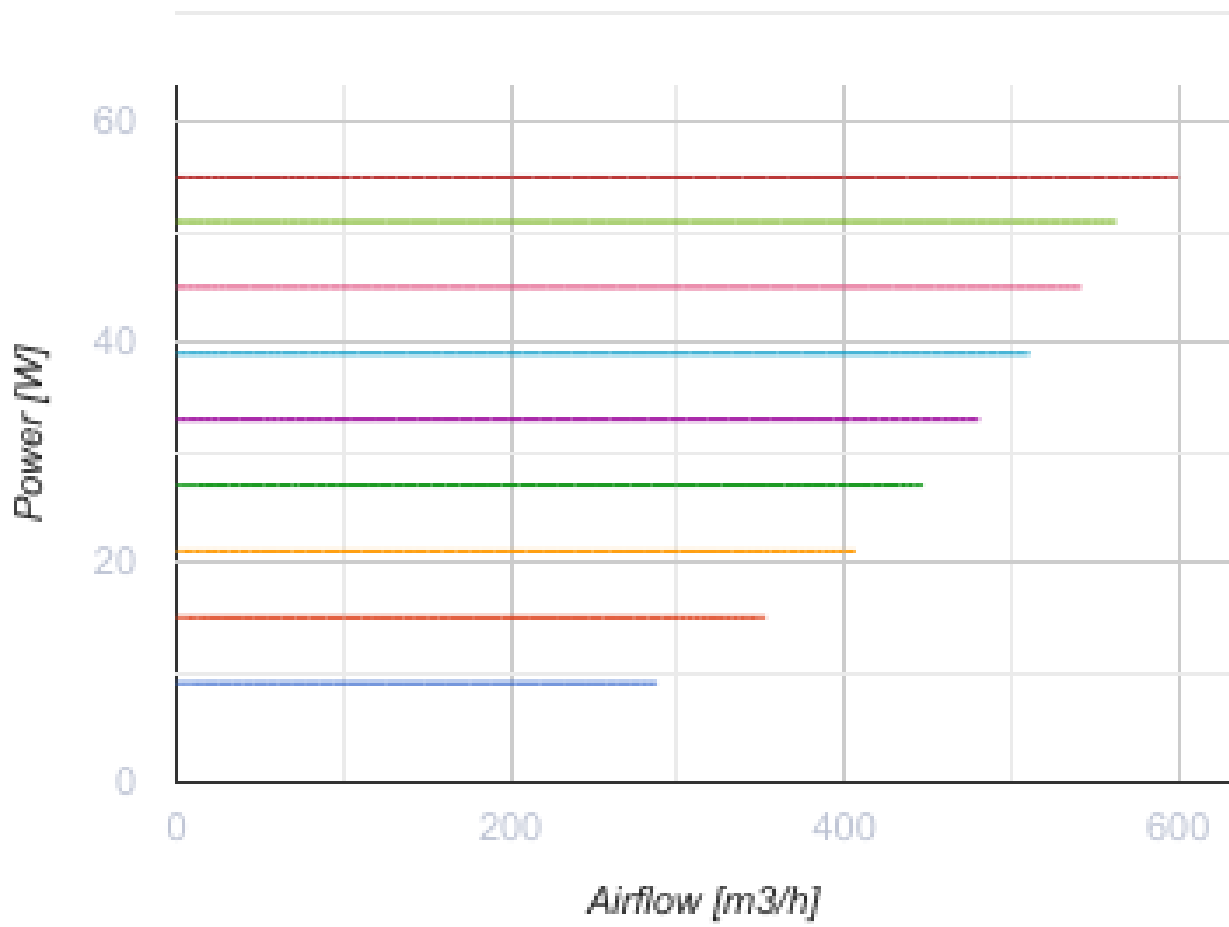





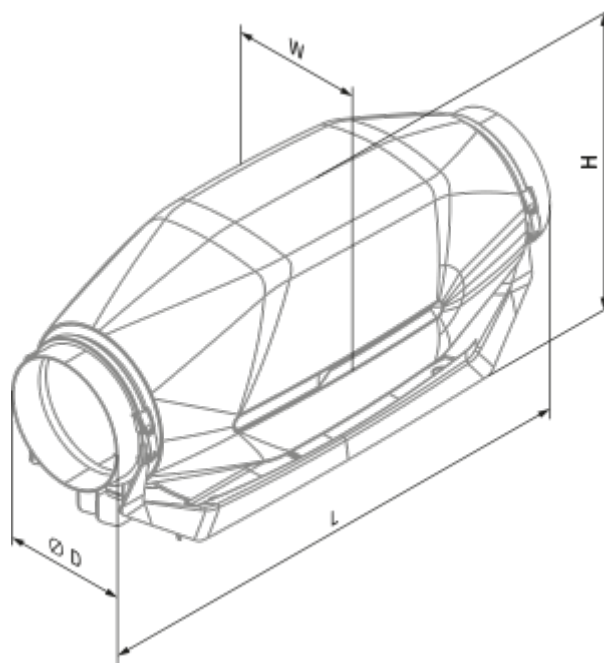

## Dimensions

Ø D	W	L	H
149 (159)	253	606	273











## Accessories

### For round ducts





Name	Photo	Description
<a href="#">SD 150/600</a>		Silencers for round ducts
<a href="#">SD 150/900</a>		Silencers for round ducts
<a href="#">SD 150/1200</a>		Silencers for round ducts
<a href="#">SD 160/600</a>		Silencers for round ducts
<a href="#">SD 160/900</a>		Silencers for round ducts
<a href="#">SD 160/1200</a>		Silencers for round ducts











### For round ducts

Name	Photo	Description
------	-------	-------------



<a href="#">KFBK 150</a>		Filter boxes for round ducts
<a href="#">KFBK 160</a>		Filter boxes for round ducts
<a href="#">KFBT 150 G4</a>		Filter boxes with pocket filters for round ducts
<a href="#">KFBT 150 F5</a>		Filter boxes with pocket filters for round ducts
<a href="#">KFBT 150 F7</a>		Filter boxes with pocket filters for round ducts
<a href="#">KFBT 160 G4</a>		Filter boxes with pocket filters for round ducts
<a href="#">KFBT 160 F5</a>		Filter boxes with pocket filters for round ducts
<a href="#">KFBT 160 F7</a>		Filter boxes with pocket filters for round ducts

## Electrical heaters

Name	Photo	Description
<a href="#">EKH 150-1.2</a>		Duct electrical heaters for round ducts
<a href="#">EKH 150-1.7</a>		Duct electrical heaters for round ducts
<a href="#">EKH 150-2.0</a>		Duct electrical heaters for round ducts
<a href="#">EKH 150-2.4</a>		Duct electrical heaters for round ducts
<a href="#">EKH 150-3.4</a>		Duct electrical heaters for round ducts



<a href="#">EKH 150-3.6</a>		Duct electrical heaters for round ducts
<a href="#">EKH 150-5.1</a>		Duct electrical heaters for round ducts
<a href="#">EKH 150-6.0</a>		Duct electrical heaters for round ducts
<a href="#">EKH 160-1.2</a>		Duct electrical heaters for round ducts
<a href="#">EKH 160-1.7</a>		Duct electrical heaters for round ducts
<a href="#">EKH 160-2.0</a>		Duct electrical heaters for round ducts
<a href="#">EKH 160-2.4</a>		Duct electrical heaters for round ducts
<a href="#">EKH 160-3.4</a>		Duct electrical heaters for round ducts
<a href="#">EKH 160-3.6</a>		Duct electrical heaters for round ducts
<a href="#">EKH 160-5.1</a>		Duct electrical heaters for round ducts
<a href="#">EKH 160-6.0</a>		Duct electrical heaters for round ducts

### Water heaters

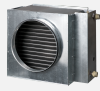
Name	Photo	Description
<a href="#">WKH 150-2</a>		Duct water heaters for round ducts
<a href="#">WKH 150-4</a>		Duct water heaters for round ducts

<a href="#">WKH 160-2</a>		Duct water heaters for round ducts
<a href="#">WKH 160-4</a>		Duct water heaters for round ducts

### For round ducts

Name	Photo	Description
<a href="#">VRV 150</a>		Backdraft dampers with spring for round ducts
<a href="#">VRV 160</a>		Backdraft dampers with spring for round ducts
<a href="#">VKA 150</a>		Air dampers for round ducts
<a href="#">VKA 160</a>		Air dampers for round ducts

### EC motors regulators

Name	Photo	Description
<a href="#">CDT E/0-10</a>		Speed control for EC motors