

inWave 150/160 FR1

Mixed-flow inline fans in sound-insulated casings

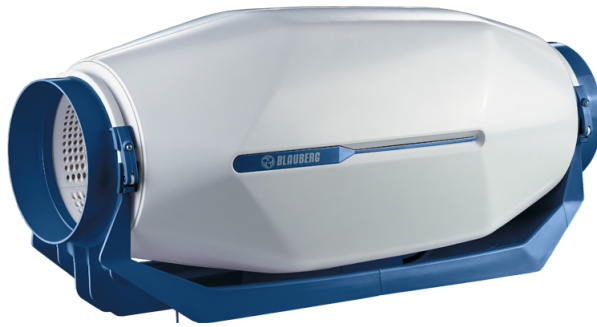

- Maximum airflow: 540
- Sound pressure level LpA at 3 m: 33
- Sound insulation
- Motor type: AC
- Control: Built-in speed controller
- Impeller type: Mixed-flow
- Casing material: Plastic
- Cable with mains plug

	Unit of measurement	inWave 150/160 FR1		
Connected air duct size	mm	160/150		
Speed	-	3		
Phases	-	1		
Minimum supply voltage	V	230		
Maximum supply voltage	V	230		
Power supply frequency	Hz	50		
Rated power	W	25	46	51
Unit current	A	0.2	0.21	0.24
Maximum airflow	m ³ /h	242	320	540
rotation speed at 50hz	-	1982	2374	2738
Sound pressure level LpA at 3 m	dB(A)	20	26	33
Weight	kg	5		
Transported air temperature (max)	°C	55		
Transported air temperature (min)	°C	-25		
Ambient air temperature min	°C	1		
Ambient air temperature max	°C	40		
Ingress protection rating	-	IPX4		
Ingress protection rating of the drive	-	IP20		

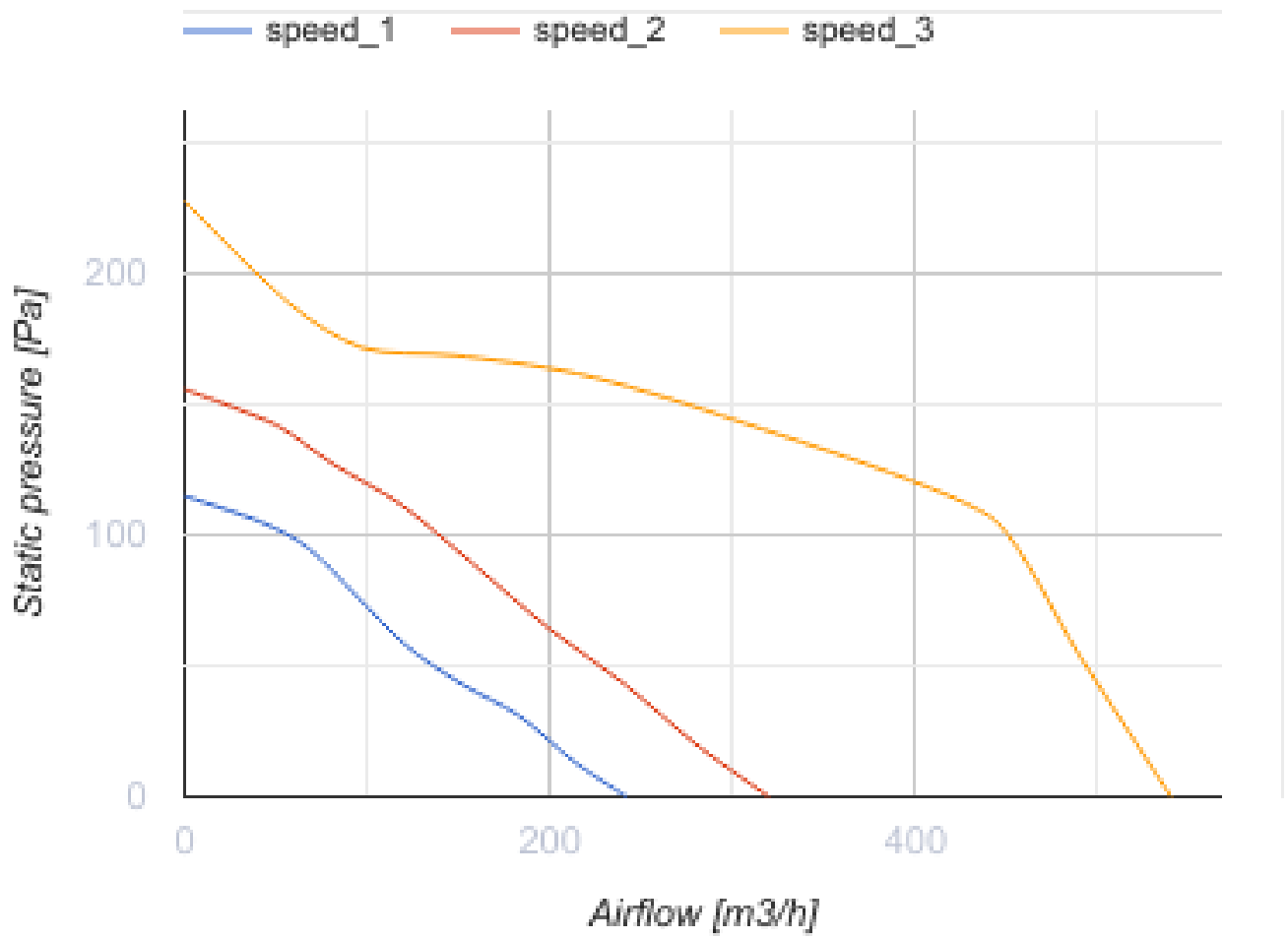

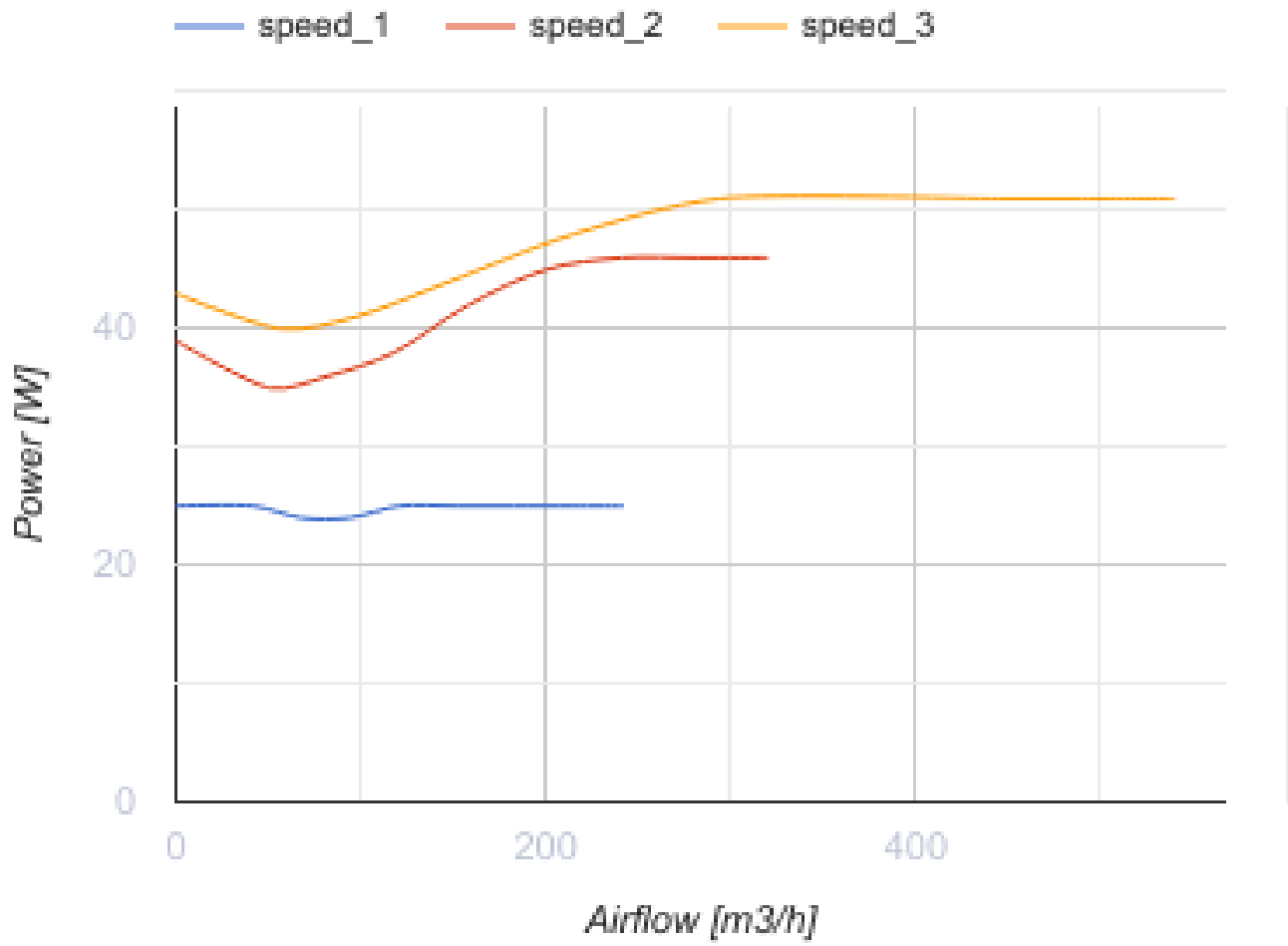





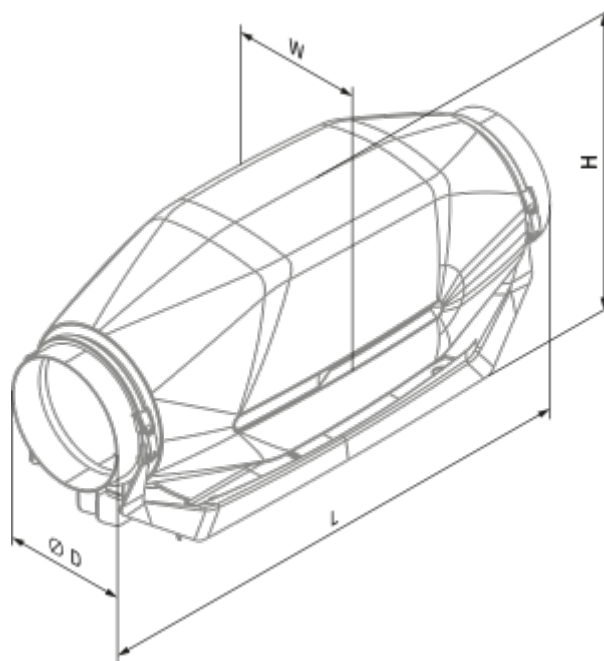

Dimensions

Ø D	W	L	H
149 (159)	253	606	273











Accessories

Other accessories





Name	Photo	Description
SD 150/600		Silencers for round ducts
SD 150/900		Silencers for round ducts
SD 150/1200		Silencers for round ducts
SD 160/600		Silencers for round ducts
SD 160/900		Silencers for round ducts
SD 160/1200		Silencers for round ducts















Other accessories

Name	Photo	Description
------	-------	-------------

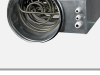
KFBK 150		Filter boxes for round ducts
KFBK 160		Filter boxes for round ducts
KFBT 150 G4		Filter boxes with pocket filters for round ducts
KFBT 150 F5		Filter boxes with pocket filters for round ducts
KFBT 150 F7		Filter boxes with pocket filters for round ducts
KFBT 160 G4		Filter boxes with pocket filters for round ducts
KFBT 160 F5		Filter boxes with pocket filters for round ducts
KFBT 160 F7		Filter boxes with pocket filters for round ducts

Other accessories

Name	Photo	Description
EKH 150-1.2		Duct electrical heaters for round ducts
EKH 150-1.7		Duct electrical heaters for round ducts
EKH 150-2.0		Duct electrical heaters for round ducts
EKH 150-2.4		Duct electrical heaters for round ducts
EKH 150-3.4		Duct electrical heaters for round ducts





EKH 150-3.6		Duct electrical heaters for round ducts
EKH 150-5.1		Duct electrical heaters for round ducts
EKH 150-6.0		Duct electrical heaters for round ducts
EKH 160-1.2		Duct electrical heaters for round ducts
EKH 160-1.7		Duct electrical heaters for round ducts
EKH 160-2.0		Duct electrical heaters for round ducts
EKH 160-2.4		Duct electrical heaters for round ducts
EKH 160-3.4		Duct electrical heaters for round ducts
EKH 160-3.6		Duct electrical heaters for round ducts
EKH 160-5.1		Duct electrical heaters for round ducts
EKH 160-6.0		Duct electrical heaters for round ducts
WKH 150-2		Duct water heaters for round ducts
WKH 150-4		Duct water heaters for round ducts
WKH 160-2		Duct water heaters for round ducts

WKH 160-4		Duct water heaters for round ducts
---------------------------	---	------------------------------------

Other accessories

Name	Photo	Description
VRV 150		Backdraft dampers with spring for round ducts
VRV 160		Backdraft dampers with spring for round ducts
VKA 150		Air dampers for round ducts
VKA 160		Air dampers for round ducts

Other accessories

Name	Photo	Description
CDP-3/5		Multi-speed switch
CDT1 E0.5		Multi-speed switches
CDT E1.8		Thyristor speed controller
CDTE E3.0 TP		Speed controllers