

# inWave 150/160

Mixed-flow inline fans in sound-insulated casings

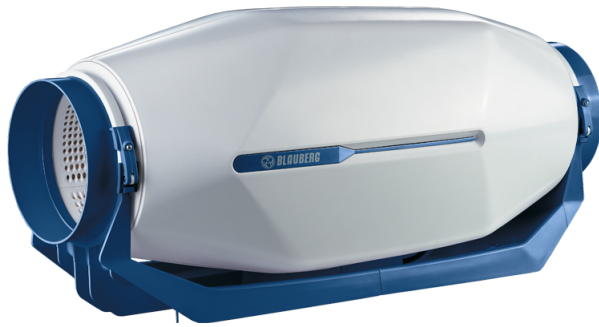

- Maximum airflow: 540
- Sound pressure level LpA at 3 m: 33
- Sound insulation
- Motor type: AC
- Impeller type: Mixed-flow
- Casing material: Plastic

	Unit of measurement	inWave 150/160		
Connected air duct size	mm	160/150		
Speed	-	3		
Phases	-	1		
Minimum supply voltage	V	230		
Maximum supply voltage	V	230		
Power supply frequency	Hz	50		
Rated power	W	25	46	51
Unit current	A	0.2	0.21	0.24
Maximum airflow	m <sup>3</sup> /h	242	320	540
rotation speed at 50hz	-	1982	2374	2738
Sound pressure level LpA at 3 m	dB(A)	20	26	33
Weight	kg	5		
Transported air temperature (max)	°C	55		
Transported air temperature (min)	°C	-25		
Ambient air temperature min	°C	1		
Ambient air temperature max	°C	40		
Ingress protection rating	-	IPX4		
Ingress protection rating of the drive	-	IP20		

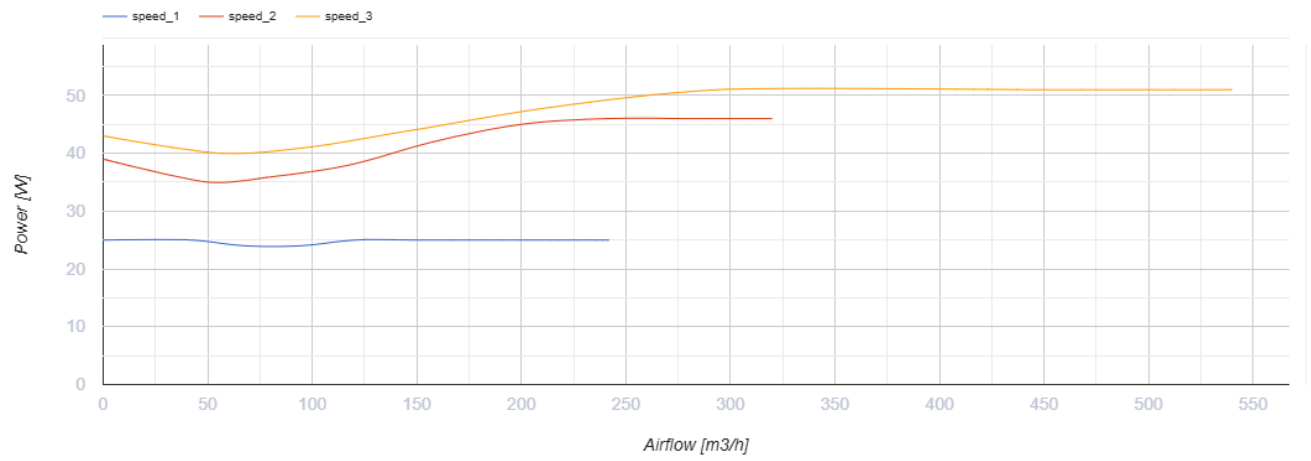
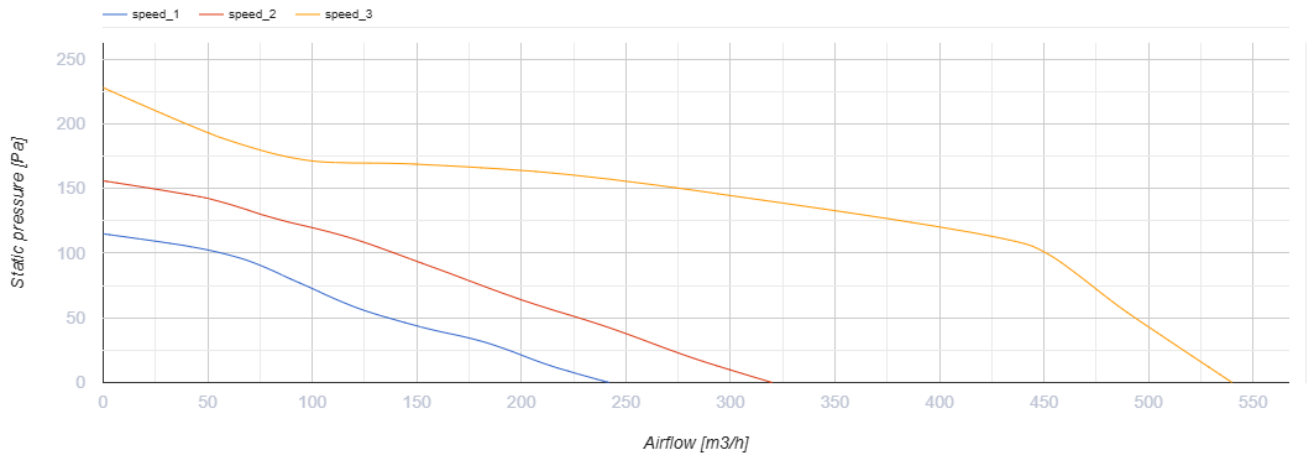





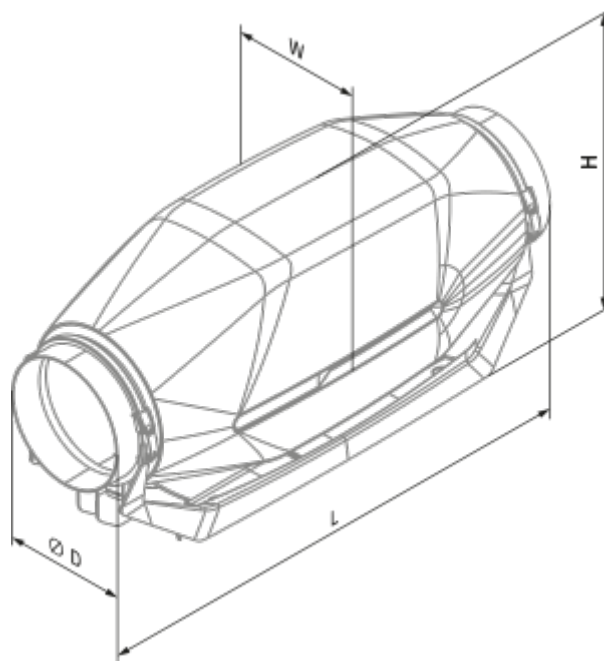

## Dimensions

Ø D	W	L	H
149 (159)	253	606	273









## Accessories

### Other accessories







Name	Photo	Description
<a href="#">SD 150/600</a>		Silencers for round ducts
<a href="#">SD 150/900</a>		Silencers for round ducts
<a href="#">SD 150/1200</a>		Silencers for round ducts
<a href="#">SD 160/600</a>		Silencers for round ducts
<a href="#">SD 160/900</a>		Silencers for round ducts
<a href="#">SD 160/1200</a>		Silencers for round ducts















### Other accessories

Name	Photo	Description
------	-------	-------------



<a href="#">KFBK 150</a>		Filter boxes for round ducts
<a href="#">KFBT 150 G4</a>		Filter boxes with pocket filters for round ducts
<a href="#">KFBT 150 F5</a>		Filter boxes with pocket filters for round ducts
<a href="#">KFBT 150 F7</a>		Filter boxes with pocket filters for round ducts
<a href="#">KFBT 160 G4</a>		Filter boxes with pocket filters for round ducts
<a href="#">KFBT 160 F5</a>		Filter boxes with pocket filters for round ducts
<a href="#">KFBT 160 F7</a>		Filter boxes with pocket filters for round ducts

### Other accessories





Name	Photo	Description
<a href="#">EKH 150-1.2</a>		Duct electrical heaters for round ducts
<a href="#">EKH 150-1.7</a>		Duct electrical heaters for round ducts
<a href="#">EKH 150-2.0</a>		Duct electrical heaters for round ducts
<a href="#">EKH 150-2.4</a>		Duct electrical heaters for round ducts
<a href="#">EKH 150-3.4</a>		Duct electrical heaters for round ducts
<a href="#">EKH 150-3.6</a>		Duct electrical heaters for round ducts

<a href="#">EKH 150-5.1</a>		Duct electrical heaters for round ducts
<a href="#">EKH 150-6.0</a>		Duct electrical heaters for round ducts
<a href="#">EKH 160-1.2</a>		Duct electrical heaters for round ducts
<a href="#">EKH 160-1.7</a>		Duct electrical heaters for round ducts
<a href="#">EKH 160-2.0</a>		Duct electrical heaters for round ducts
<a href="#">EKH 160-2.4</a>		Duct electrical heaters for round ducts
<a href="#">EKH 160-3.4</a>		Duct electrical heaters for round ducts
<a href="#">EKH 160-3.6</a>		Duct electrical heaters for round ducts
<a href="#">EKH 160-5.1</a>		Duct electrical heaters for round ducts
<a href="#">EKH 160-6.0</a>		Duct electrical heaters for round ducts
<a href="#">WKH 150-2</a>		Duct water heaters for round ducts
<a href="#">WKH 150-4</a>		Duct water heaters for round ducts
<a href="#">WKH 160-2</a>		Duct water heaters for round ducts
<a href="#">WKH 160-4</a>		Duct water heaters for round ducts

### Other accessories

Name	Photo	Description
<a href="#">VRV 150</a>		Backdraft dampers with spring for round ducts
<a href="#">VRV 160</a>		Backdraft dampers with spring for round ducts
<a href="#">VKA 150</a>		Air dampers for round ducts
<a href="#">VKA 160</a>		Air dampers for round ducts

### Other accessories

Name	Photo	Description
<a href="#">CDP-3/5</a>		Multi-speed switch
<a href="#">CDT1 E0.5</a>		Multi-speed switches
<a href="#">CDT E1.8</a>		Thyristor speed controller
<a href="#">CDTE E3.0 TP</a>		Speed controllers