

inWave EC 100/125 FR1

Mixed-flow inline fans in sound-insulated casings with EC-motors

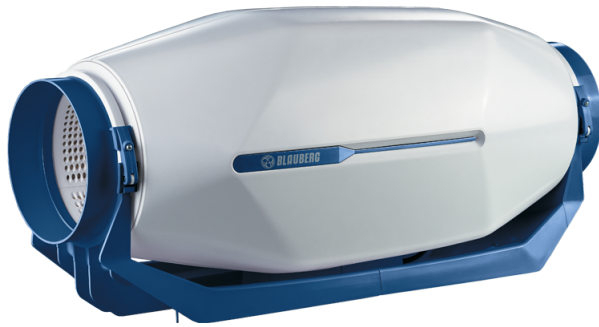

- Maximum airflow: 350
- Sound pressure level LpA at 3 m: 28
- Sound insulation
- Motor type: EC
- Control: Built-in speed controller
- Impeller type: Mixed-flow
- Casing material: Plastic
- Cable with mains plug

	Unit of measurement	inWave EC 100/125 FR1
Connected air duct size	mm	125
Speed	-	1
Phases	-	1
Minimum supply voltage	V	230
Maximum supply voltage	V	230
Power supply frequency	Hz	50/60
Rated power	W	20
Unit current	A	0.77
Maximum airflow	m ³ /h	350
rotation speed at 50hz	-	3002
Sound pressure level LpA at 3 m	dB(A)	28
Weight	kg	3.6
Transported air temperature (max)	°C	55
Transported air temperature (min)	°C	-25
Ambient air temperature min	°C	1
Ambient air temperature max	°C	40
Ingress protection rating	-	IPX4
Ingress protection rating of the drive	-	IP44

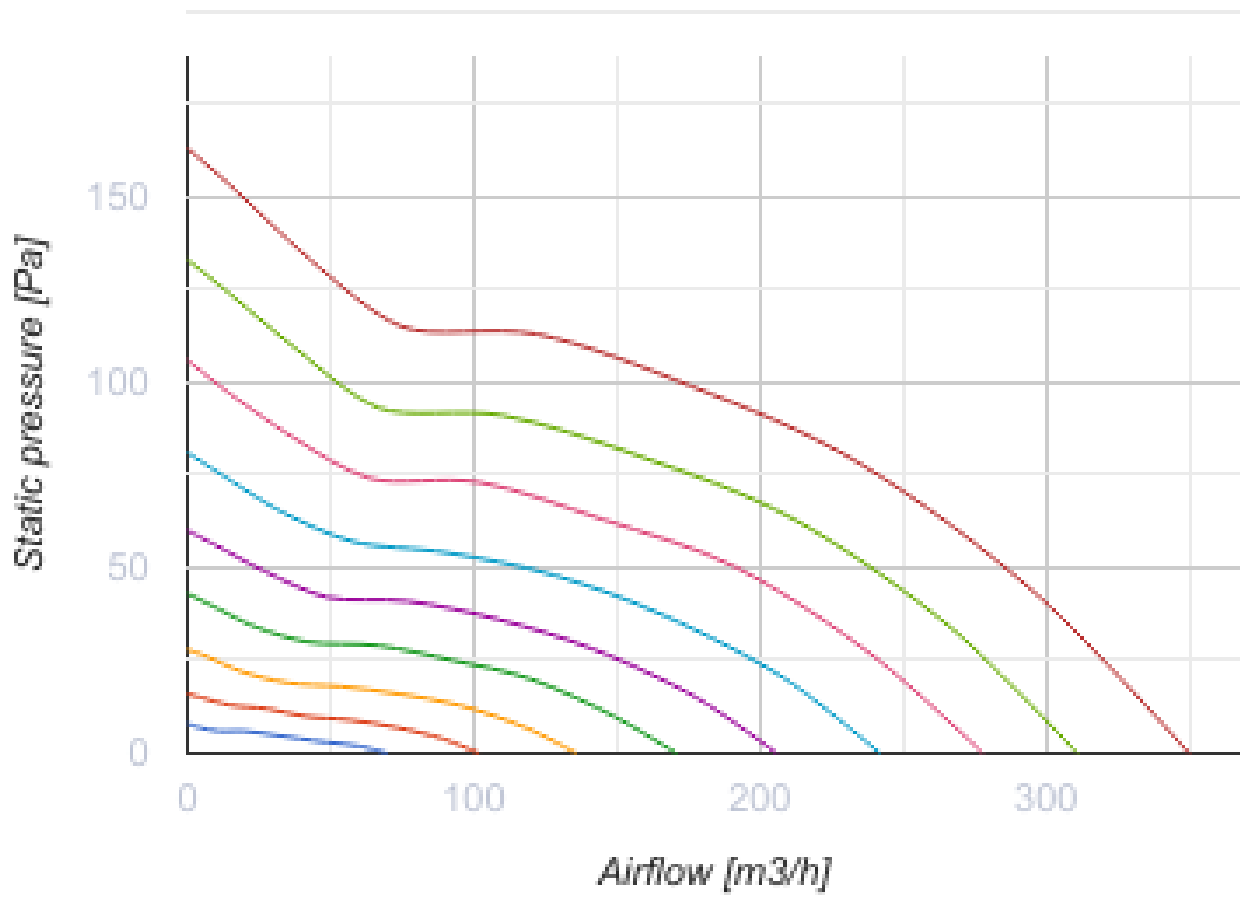

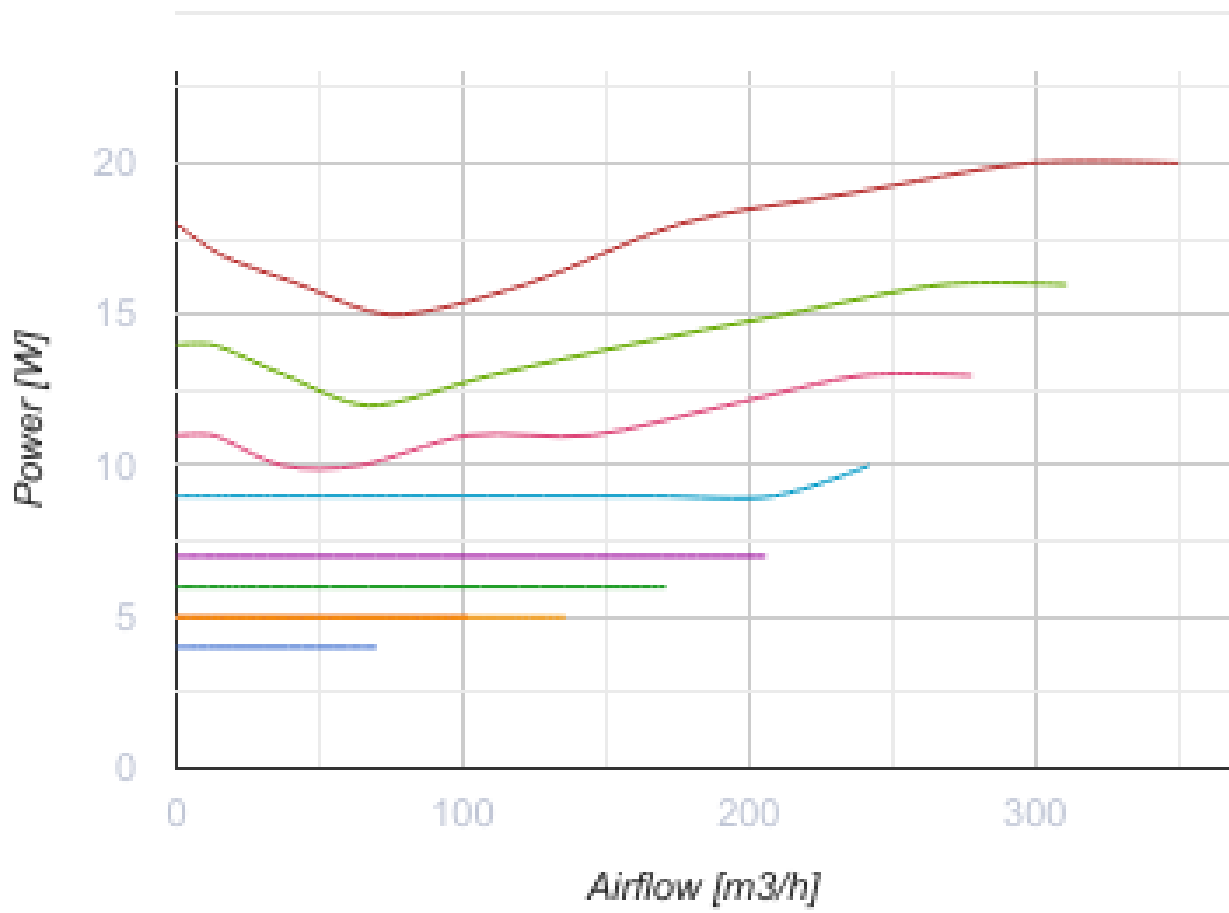

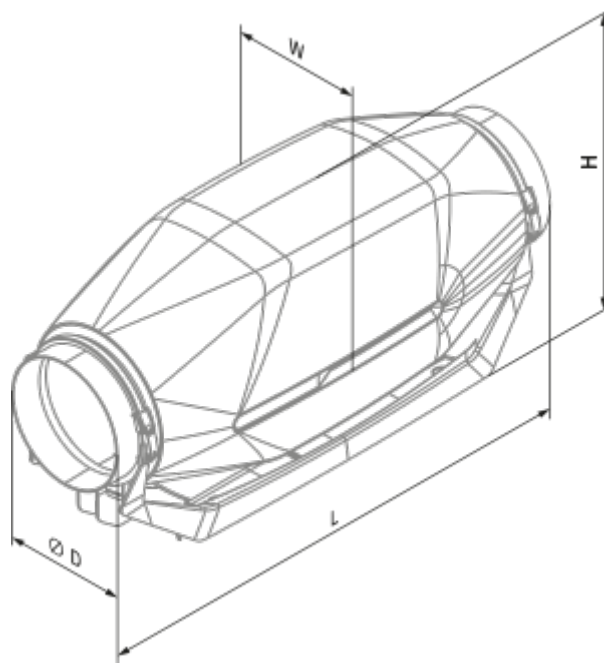

Dimensions

Ø D	W	L	H
125	207	502	224







Accessories

Other accessories







Name	Photo	Description
SD 125/600		Silencers for round ducts
SD 125/900		Silencers for round ducts
SD 125/1200		Silencers for round ducts

Other accessories

Name	Photo	Description
KFBT 125 G4		Filter boxes with pocket filters for round ducts
KFBT 125 F5		Filter boxes with pocket filters for round ducts
KFBT 125 F7		Filter boxes with pocket filters for round ducts

KFBK 125		Filter boxes for round ducts
--------------------------	---	------------------------------

Other accessories

Name	Photo	Description
EKH 125-0.6		Duct electrical heaters for round ducts
EKH 125-0.8		Duct electrical heaters for round ducts
EKH 125-1.2		Duct electrical heaters for round ducts
EKH 125-1.6		Duct electrical heaters for round ducts
EKH 125-2.4		Duct electrical heaters for round ducts
WKH 125-2		Duct water heaters for round ducts
WKH 125-4		Duct water heaters for round ducts

Other accessories

Name	Photo	Description
VRV 125		Backdraft dampers with spring for round ducts
VKA 125		Air dampers for round ducts

Other accessories

Name	Photo	Description
CDT E/0-10		Speed control for EC motors