

inWave EC 100/125

Sound-insulated inline mixed-flow fans with EC motor

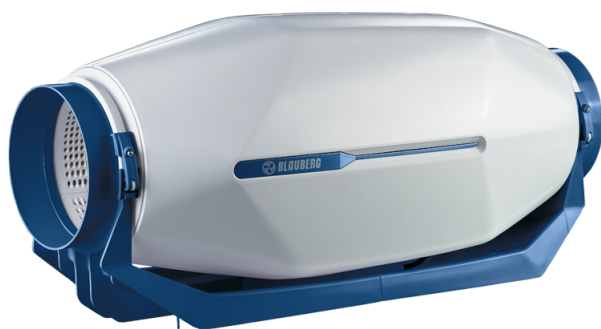

- Maximum airflow: 350
- Sound pressure level LpA at 3 m: 28
- Sound insulation
- Motor type: EC
- Impeller type: Mixed-flow
- Casing material: Plastic

	Unit of measurement	inWave EC 100/125
Connected air duct size	mm	125
Speed	-	1
Phases	-	1
Minimum supply voltage	V	230
Maximum supply voltage	V	230
Power supply frequency	Hz	50/60
Rated power	W	20
Unit current	A	0.77
Maximum airflow	m ³ /h	350
rotation speed at 50hz	-	3002
Sound pressure level LpA at 3 m	dB(A)	28
Weight	kg	3.6
Transported air temperature (max)	°C	55
Transported air temperature (min)	°C	-25
Ambient air temperature min	°C	1
Ambient air temperature max	°C	40
Ingress protection rating	-	IPX4
Ingress protection rating of the drive	-	IP44

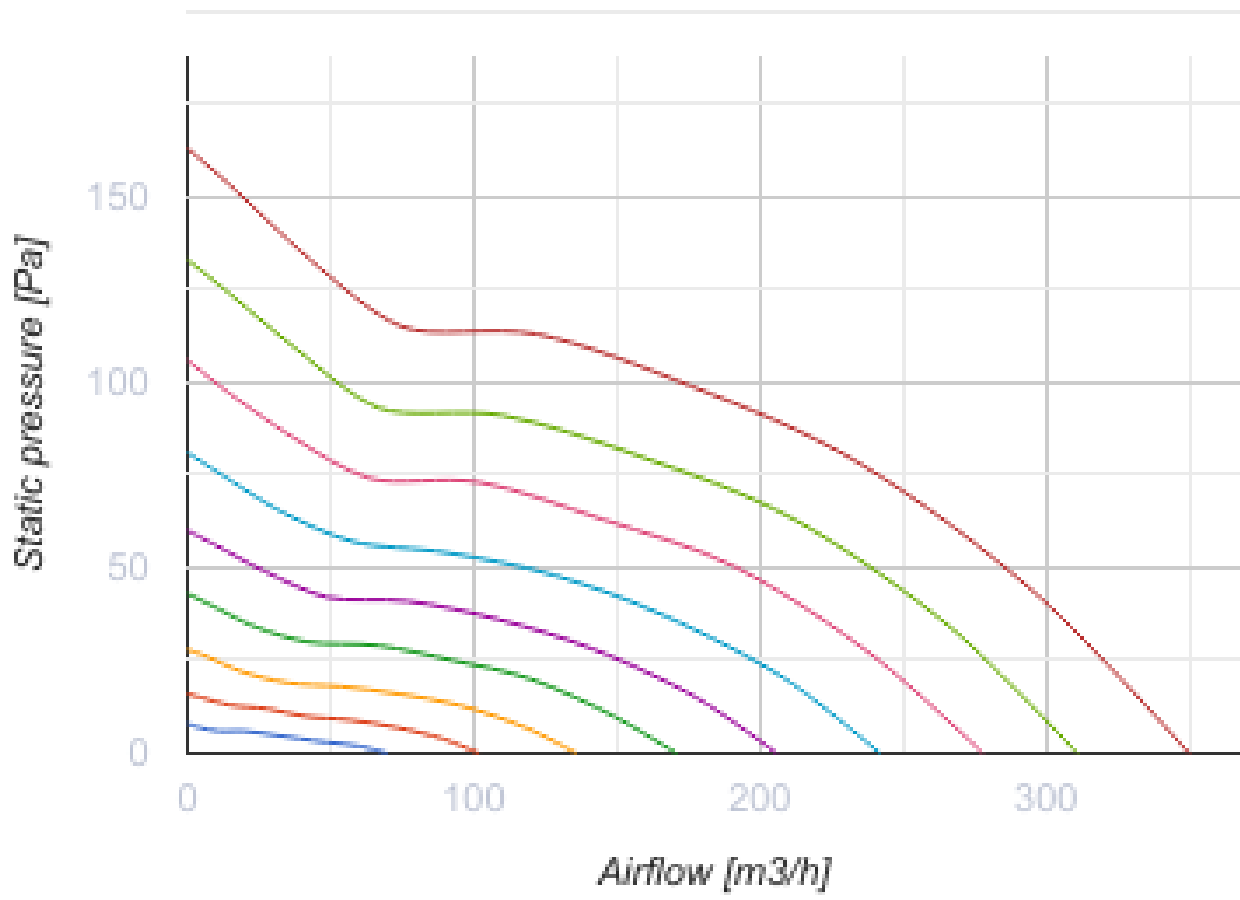

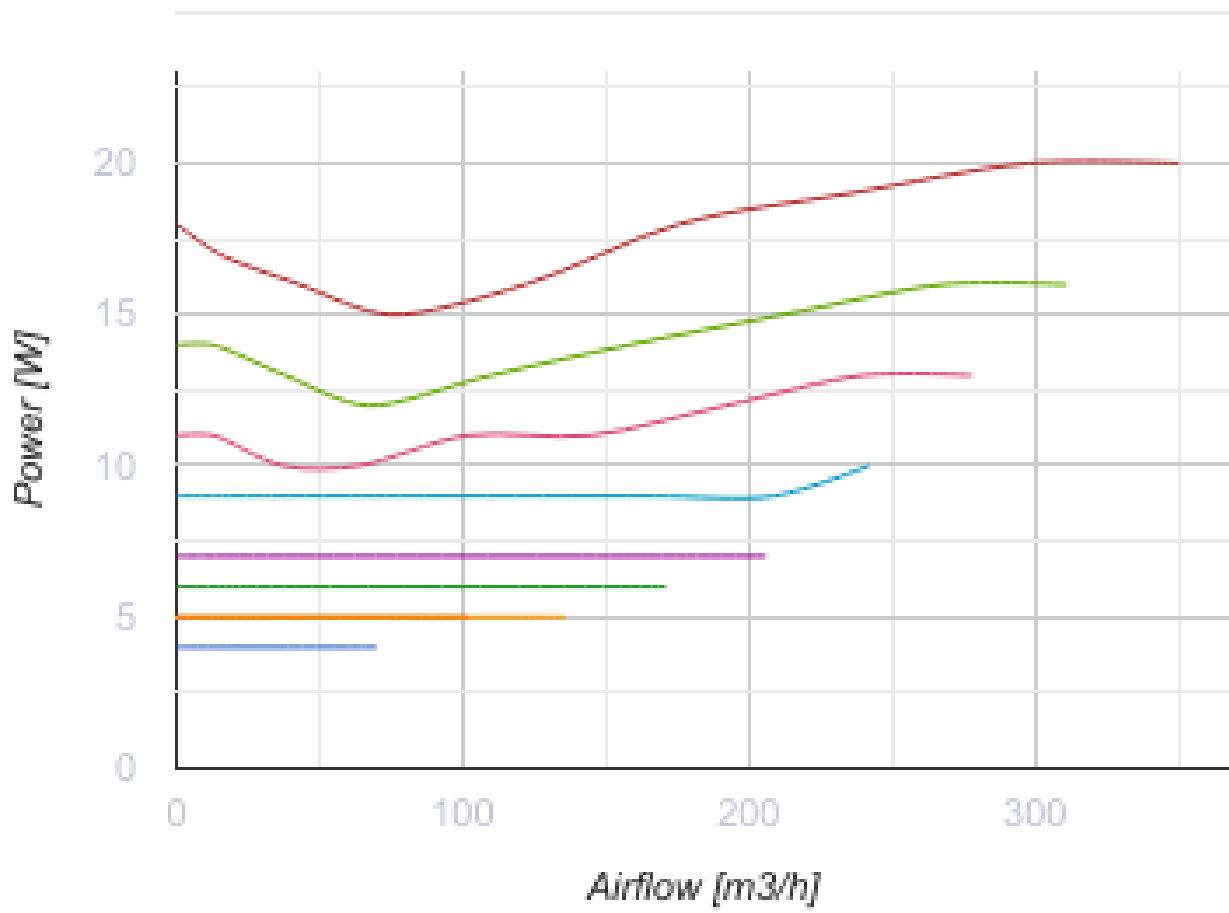

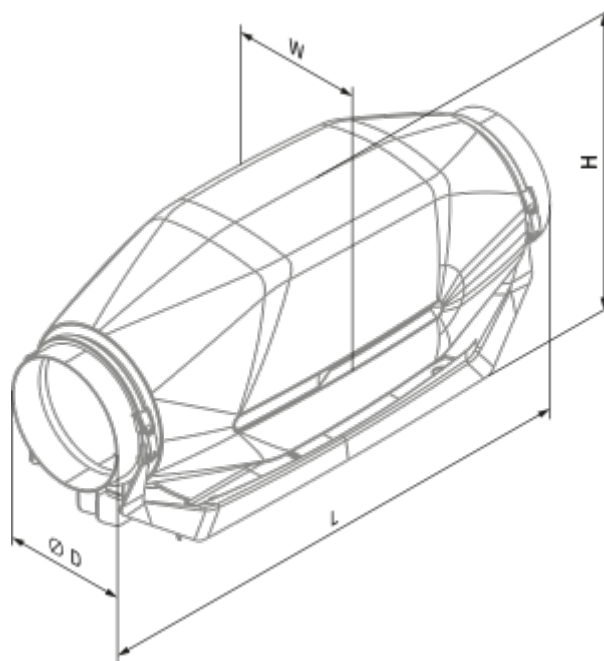

Dimensions

Ø D	W	L	H
125	207	502	224







Accessories

For round ducts





Name	Photo	Description
SD 125/600		Silencers for round ducts
SD 125/900		Silencers for round ducts
SD 125/1200		Silencers for round ducts

For round ducts



Name	Photo	Description
KFBK 125		Filter boxes for round ducts
KFBT 125 G4		Filter boxes with pocket filters for round ducts
KFBT 125 F5		Filter boxes with pocket filters for round ducts

KFBT 125 F7		Filter boxes with pocket filters for round ducts
-----------------------------	---	--

Electrical heaters

Name	Photo	Description
EKH 125-0.6		Duct electrical heaters for round ducts
EKH 125-0.8		Duct electrical heaters for round ducts
EKH 125-1.2		Duct electrical heaters for round ducts
EKH 125-1.6		Duct electrical heaters for round ducts
EKH 125-2.4		Duct electrical heaters for round ducts

Water heaters

Name	Photo	Description
WKH 125-2		Duct water heaters for round ducts
WKH 125-4		Duct water heaters for round ducts

For round ducts

Name	Photo	Description
VRV 125		Backdraft dampers with spring for round ducts
VKA 125		Air dampers for round ducts

EC motors regulators

Name	Photo	Description
------	-------	-------------

[CDT E/0-10](#)



Speed control for EC motors