

# inWave 100/125 (125 spigot)

Sound-insulated inline mixed-flow fans

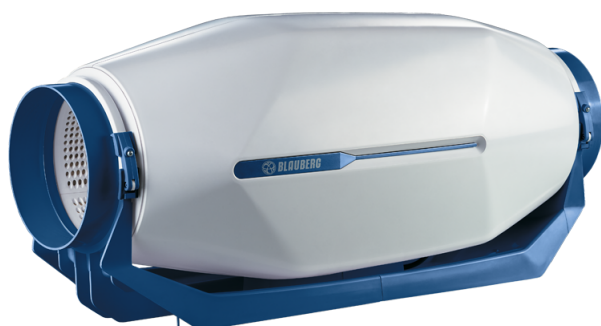

- Maximum airflow: 320
- Sound pressure level LpA at 3 m: 28
- Sound insulation
- Motor type: AC
- Impeller type: Mixed
- Casing material: Plastic
- Installation in any position

	Unit of measurement	inWave 100/125 (125 spigot)		
Connected air duct size	mm	125		
Speed	-	3		
Phases	-	1		
Minimum supply voltage	V	230		
Maximum supply voltage	V	230		
Power supply frequency	Hz	50		
Rated power	W	31	33	34
Unit current	A	0.14	0.14	0.16
Maximum airflow	m <sup>3</sup> /h	164	216	320
rotation speed at 50hz	-	1552	1952	2356
Sound pressure level LpA at 3 m	dB(A)	20	22	28
Weight	kg	5		
Transported air temperature (max)	°C	55		
Transported air temperature (min)	°C	-25		
Ingress protection rating	-	IPX4		
Ingress protection rating of the drive	-	IP20		

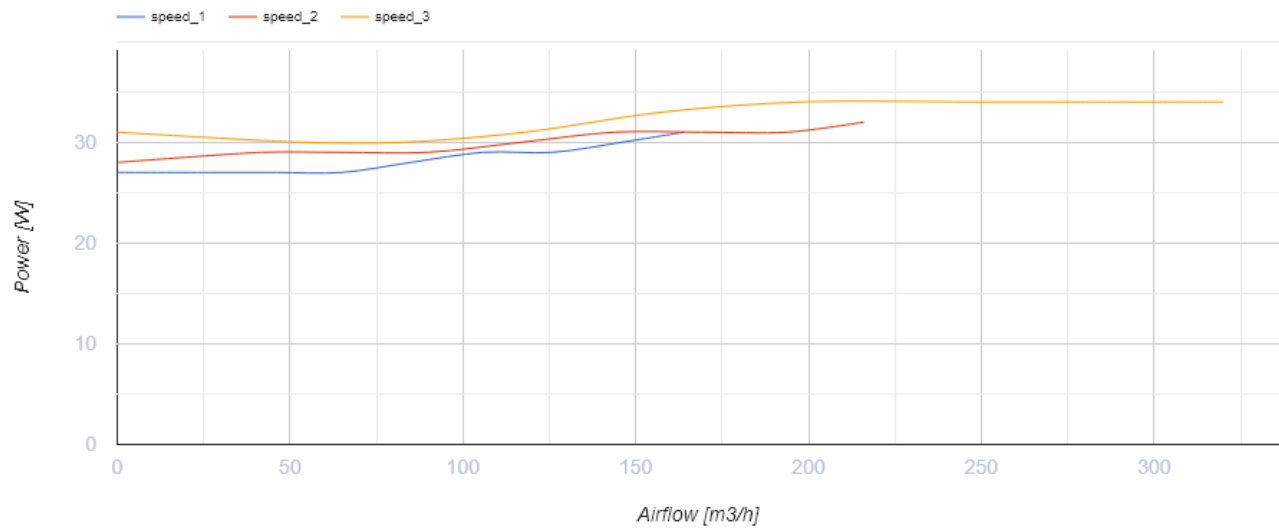
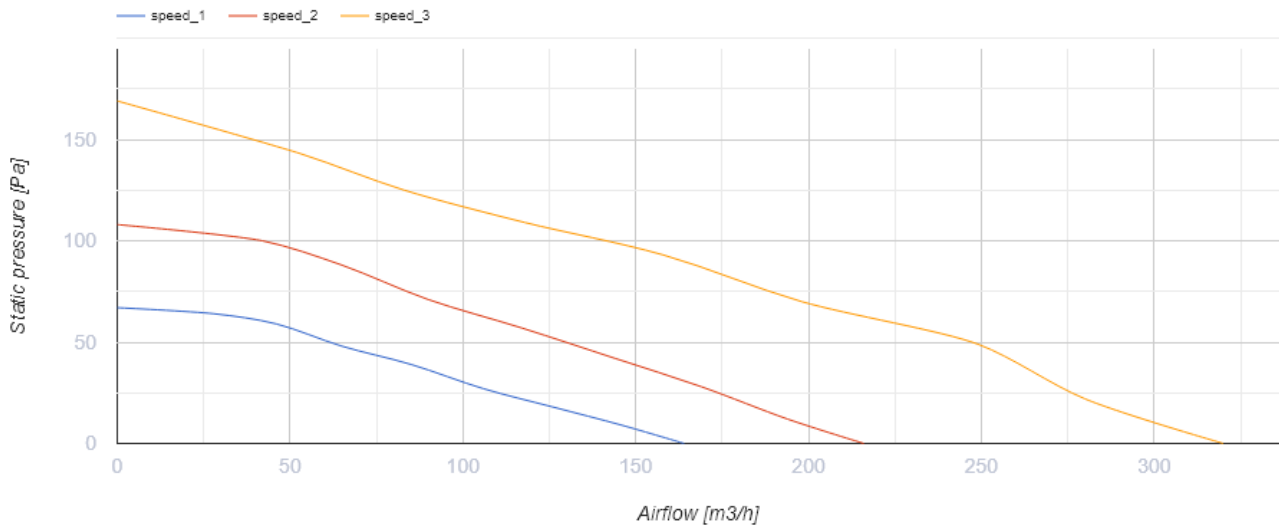

## Dimensions

Ø D	H	L	W
124	273	679	253



inWave 100/125 (spigot 125 mm)

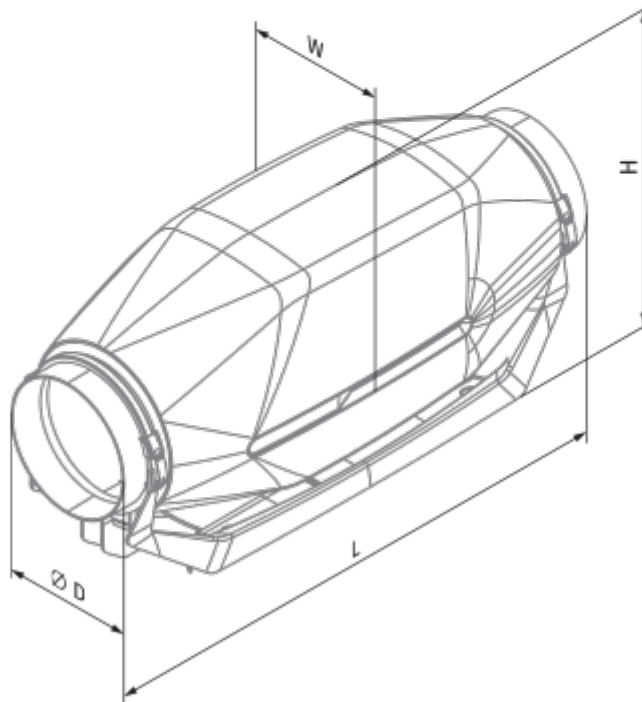



## Ecodesign







Trademark	Blauberg					
Model	inWave 100/125 (125 spigot)					
Specific energy consumption (SEC) (kWh/(m <sup>2</sup> /a))	Cold		Average		Warm	
	54	A+	26.9	B	11.4	E
Type of ventilation unit	Unidirectional					
Type of drive installed	Variable speed					
Type of heat recovery system	None					
Maximum flow rate (m <sup>3</sup> /h)	320					
Electric power input (W)	34					
Reference flow rate (m <sup>3</sup> /s)	0.062					
Specific power input (SPI) (W/(m <sup>3</sup> /h))	0.106					
Control typology	Central demand control					
Maximum external leakage rates (%)	2.7					
Sound power level (dB(A))	28					
Declared typology	RVU UVU					
The annual electricity consumption (AEC) (kWh/a)	Cold		Average		Warm	
	56		56		56	
The annual heating saved (AHS) (kWh/a)	Cold		Average		Warm	
	5536		2830		1280	

## Accessories







### Other accessories

Name	Photo	Description
<a href="#">SD 125/600</a>		Silencers for round ducts
<a href="#">SD 125/1200</a>		Silencers for round ducts
<a href="#">SD 125/900</a>		Silencers for round ducts

### Other accessories



Name	Photo	Description
<a href="#">KFBT 125 F5</a>		Filter boxes with pocket filters for round ducts
<a href="#">KFBT 125 G4</a>		Filter boxes with pocket filters for round ducts
<a href="#">KFBT 125 F7</a>		Filter boxes with pocket filters for round ducts
<a href="#">KFBK 125</a>		Filter boxes for round ducts

### Other accessories



Name	Photo	Description
<a href="#">EKH 125-0.8</a>		Duct electrical heaters for round ducts
<a href="#">EKH 125-0.6</a>		Duct electrical heaters for round ducts
<a href="#">WKH 125-4</a>		Duct water heaters for round ducts
<a href="#">WKH 125-2</a>		Duct water heaters for round ducts
<a href="#">EKH 125-2.4</a>		Duct electrical heaters for round ducts
<a href="#">EKH 125-1.6</a>		Duct electrical heaters for round ducts
<a href="#">EKH 125-1.2</a>		Duct electrical heaters for round ducts

### Other accessories



Name	Photo	Description
<a href="#">IRSE / IRSI 1.5</a>		Sensors

<a href="#">LSE / LSI 1.5</a>		Sensors
<a href="#">HSE / HSI 1.5</a>		Sensors
<a href="#">TE / TI 1.5</a>		Timers

### Other accessories

Name	Photo	Description
<a href="#">CDT E0.5</a>		Thyristor speed controller
<a href="#">CDP-3/5</a>		Multi-speed switch
<a href="#">MLCD E2</a>		Room temperature regulator

### Other accessories

Name	Photo	Description
<a href="#">VKA 125</a>		Air dampers for round ducts
<a href="#">VRV 125</a>		Backdraft dampers with spring for round ducts