

inWave 100/125 (100 spigot) W1

Sound-insulated inline mixed-flow fans



- Maximum airflow: 220
- Sound pressure level LpA at 3 m: 27
- Sound insulation
- Motor type: AC
- Impeller type: Mixed
- Casing material: Plastic
- Installation in any position
- Cable with mains plug

	Unit of measurement	inWave 100/125 (100 spigot) W1		
Connected air duct size	mm	100		
Speed	-	3		
Phases	-	1		
Minimum supply voltage	V	230		
Maximum supply voltage	V	230		
Power supply frequency	Hz	50		
Rated power	W	28	31	32
Unit current	A	0.13	0.14	0.15
Maximum airflow	m ³ /h	114	147	220
rotation speed at 50hz	-	1568	1952	2362
Sound pressure level LpA at 3 m	dB(A)	19	23	27
Weight	kg	5		
Transported air temperature (max)	°C	55		
Transported air temperature (min)	°C	-25		
Ingress protection rating	-	IPX4		
Ingress protection rating of the drive	-	IP20		

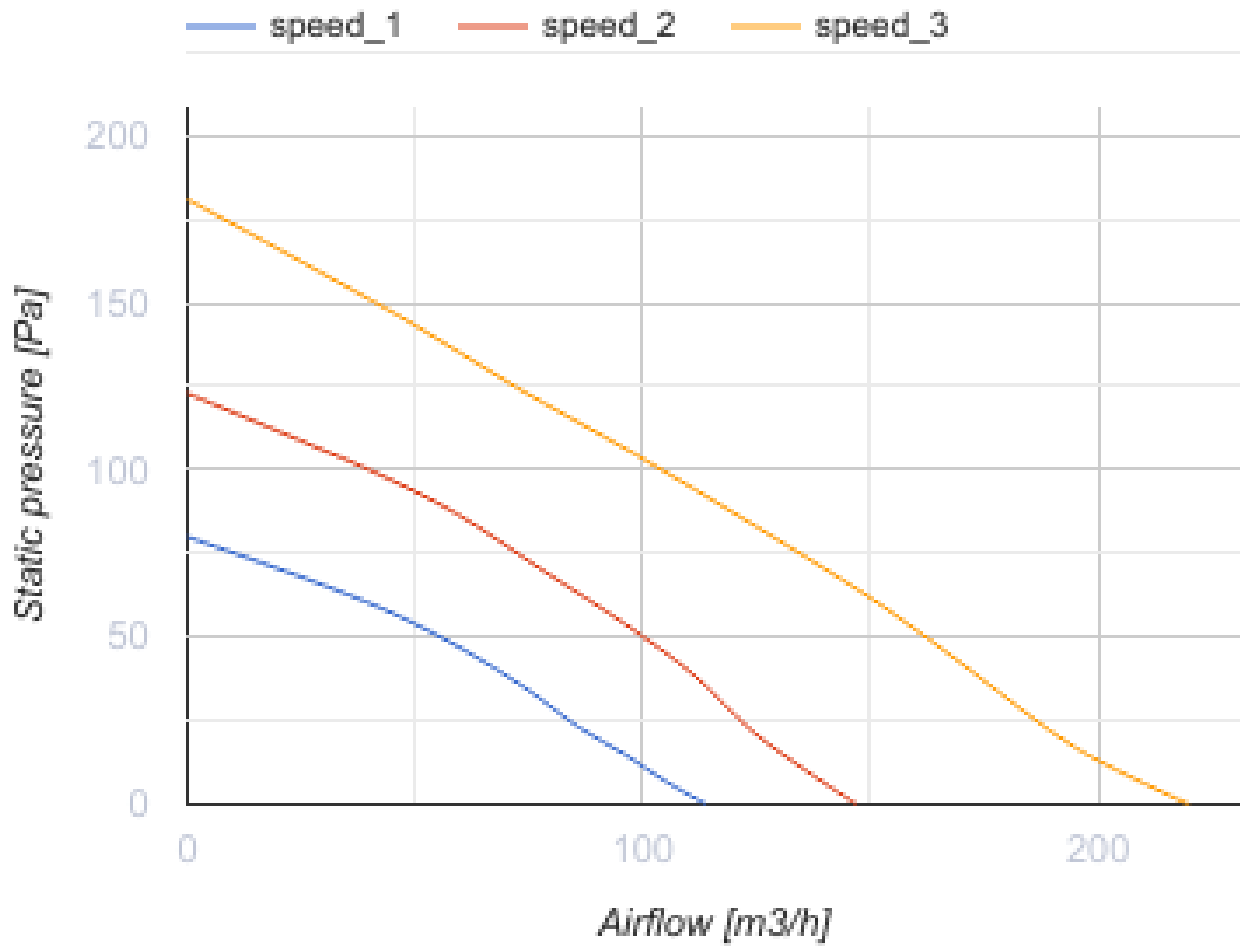



Dimensions

Ø D	H	L	W
99	273	752	253



inWave 100/125 (spigot 100 mm)

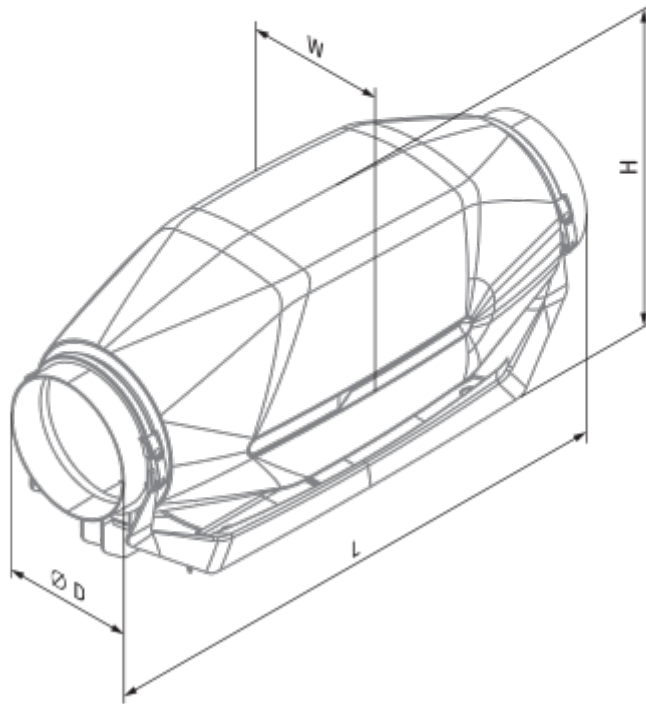



Ecodesign







Trademark	Blauberg					
Model	inWave 100/125 (100 spigot) W1					
Specific energy consumption (SEC) (kWh/(m ² /a))	Cold		Average		Warm	
	54	A+	26.9	B	11.4	E
Type of ventilation unit	Unidirectional					
Type of drive installed	Variable speed					
Type of heat recovery system	None					
Maximum flow rate (m ³ /h)	320					
Electric power input (W)	34					
Reference flow rate (m ³ /s)	0.062					
Specific power input (SPI) (W/(m ³ /h))	0.106					
Control typology	Local demand control					
Maximum external leakage rates (%)	2.7					
Sound power level (dB(A))	28					
Declared typology	RVU UVU					
The annual electricity consumption (AEC) (kWh/a)	Cold		Average		Warm	
	56		56		56	
The annual heating saved (AHS) (kWh/a)	Cold		Average		Warm	
	5536		2830		1280	

Accessories







Other accessories

Name	Photo	Description
SD 100/600		Silencers for round ducts
SD 100/900		Silencers for round ducts
SD 100/1200		Silencers for round ducts

Other accessories

Name	Photo	Description
KFBK 100		Filter boxes for round ducts
KFBT 100 G4		Filter boxes with pocket filters for round ducts
KFBT 100 F5		Filter boxes with pocket filters for round ducts
KFBT 100 F7		Filter boxes with pocket filters for round ducts

Other accessories



Name	Photo	Description
EKH 100-0.6		Duct electrical heaters for round ducts
EKH 100-0.8		Duct electrical heaters for round ducts
EKH 100-1.2		Duct electrical heaters for round ducts
EKH 100-1.6		Duct electrical heaters for round ducts
EKH 100-1.8		Duct electrical heaters for round ducts
WKH 100-2		Duct water heaters for round ducts
WKH 100-4		Duct water heaters for round ducts

Other accessories





Name	Photo	Description
VRV 100		Backdraft dampers with spring for round ducts

VKA 100		Air dampers for round ducts
-------------------------	---	-----------------------------

Other accessories

Name	Photo	Description
MLCD E2		Room temperature regulator
CDP-3/5		Multi-speed switch
CDT E0.5		Thyristor speed controller

Other accessories

Name	Photo	Description
TE / TI 1.5		Timers
HSE / HSI 1.5		Sensors
LSE / LSI 1.5		Sensors
IRSE / IRSI 1.5		Sensors