

inWave 100/125

Mixed-flow inline fans in sound-insulated casings

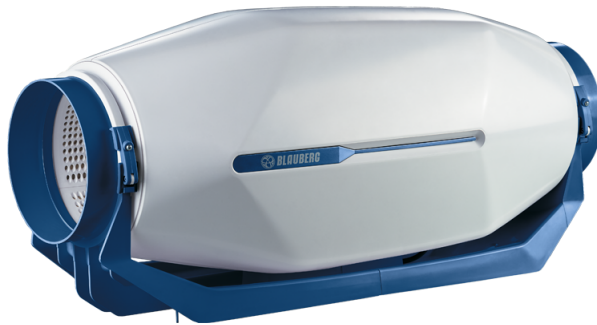

- Maximum airflow: 320
- Sound pressure level LpA at 3 m: 25
- Sound insulation
- Motor type: AC
- Impeller type: Mixed-flow
- Casing material: Plastic

	Unit of measurement	inWave 100/125		
Connected air duct size	mm	125		
Speed	-	3		
Phases	-	1		
Minimum supply voltage	V	230		
Maximum supply voltage	V	230		
Power supply frequency	Hz	50/60		
Rated power	W	9	13	21
Unit current	A	0.81	0.09	0.1
Maximum airflow	m ³ /h	173	240	320
rotation speed at 50hz	-	2252	2662	2810
Sound pressure level LpA at 3 m	dB(A)	16	21	25
Weight	kg	3.6		
Transported air temperature (max)	°C	55		
Transported air temperature (min)	°C	-25		
Ambient air temperature min	°C	1		
Ambient air temperature max	°C	40		
Ingress protection rating	-	IPX4		
Ingress protection rating of the drive	-	IP44		

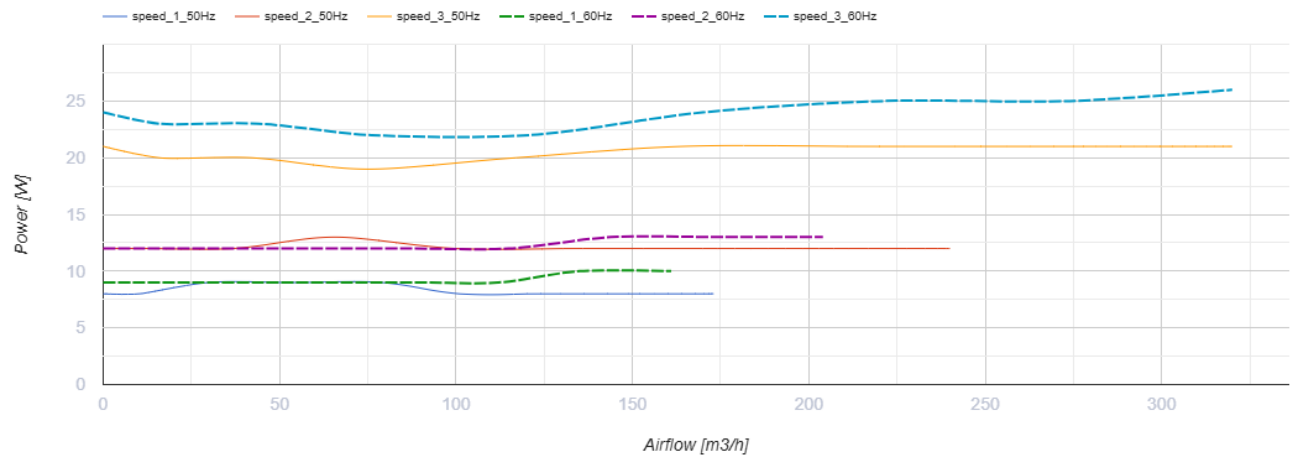
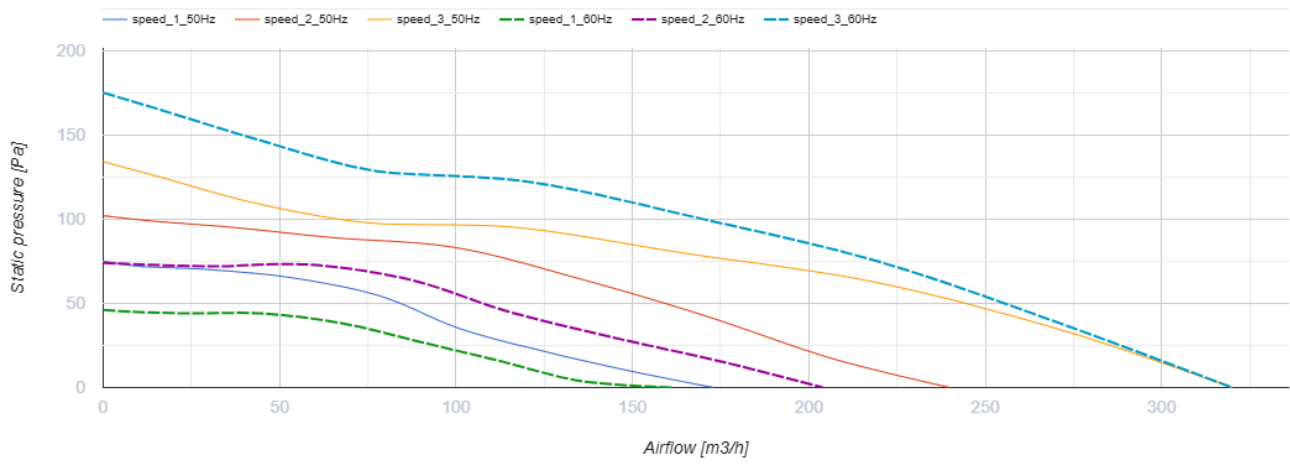

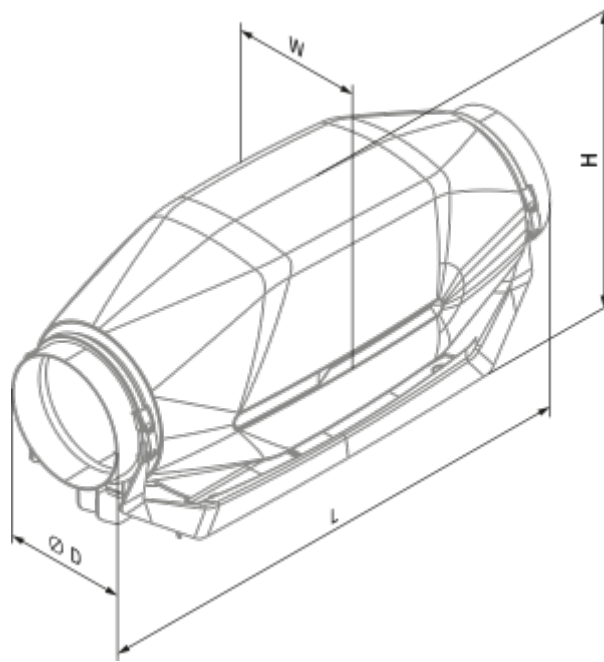

Dimensions

Ø D	H	L	W
125	224	502	207







Accessories

Other accessories







Name	Photo	Description
SD 125/600		Silencers for round ducts
SD 125/900		Silencers for round ducts
SD 125/1200		Silencers for round ducts

Other accessories

Name	Photo	Description
KFBK 125		Filter boxes for round ducts
KFBT 125 G4		Filter boxes with pocket filters for round ducts
KFBT 125 F5		Filter boxes with pocket filters for round ducts

KFBT 125 F7		Filter boxes with pocket filters for round ducts
-----------------------------	---	--

Other accessories



Name	Photo	Description
EKH 125-0.6		Duct electrical heaters for round ducts
EKH 125-0.8		Duct electrical heaters for round ducts
EKH 125-1.2		Duct electrical heaters for round ducts
EKH 125-1.6		Duct electrical heaters for round ducts
EKH 125-2.4		Duct electrical heaters for round ducts
WKH 125-2		Duct water heaters for round ducts
WKH 125-4		Duct water heaters for round ducts

Other accessories

Name	Photo	Description
VRV 125		Backdraft dampers with spring for round ducts
VKA 125		Air dampers for round ducts

Other accessories

Name	Photo	Description
CDP-3/5		Multi-speed switch

CDT1 E0.5		Multi-speed switches
CDT E1.8		Thyristor speed controller
CDTE E3.0 TP		Speed controllers