

Hybrid L S14

Centralised ventilation unit for small apartments

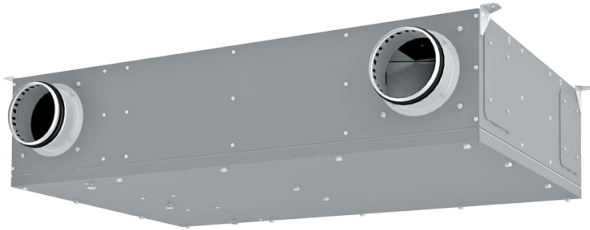

- Maximum airflow: 160
- Sound pressure level LpA at 3 m: 33
- Sound pressure level LpA at 1 m: 42
- Heat exchanger type: Counter flow
- Sound insulation
- Motor type: EC
- Bypass: Auto
- BMS protocol: ModBus
- Control: Wireless control panel
- Casing material: Galvanized steel
- Humidity sensor: Optional
- CO2 sensor: Optional
- VOC sensor: Optional
- PM2.5 sensor: Optional
- Temperature sensor: Built-in

| | Unit of measurement | Hybrid L S14 | | |
|-----------------------------------|---------------------|--------------|----|-----|
| Connected air duct size | mm | 125 | | |
| Speed | - | 3 | | |
| Minimum supply voltage | V | 230 | | |
| Maximum supply voltage | V | 230 | | |
| Power supply frequency | Hz | 50/60 | | |
| Rated power | W | 58 | | |
| Unit current | A | 0.5 | | |
| Maximum airflow | m ³ /h | 60 | 90 | 160 |
| Sound pressure level LpA at 3 m | dB(A) | 33 | | |
| Sound pressure level LpA at 1 m | dB(A) | 42 | | |
| Heat recovery efficiency, max | % | 95 | | |
| Heat exchanger type | - | Counter flow | | |
| Heat exchanger material | - | Polystyrene | | |
| Weight | kg | 31 | | |
| Transported air temperature (max) | °C | 40 | | |
| Transported air temperature (min) | °C | -25 | | |

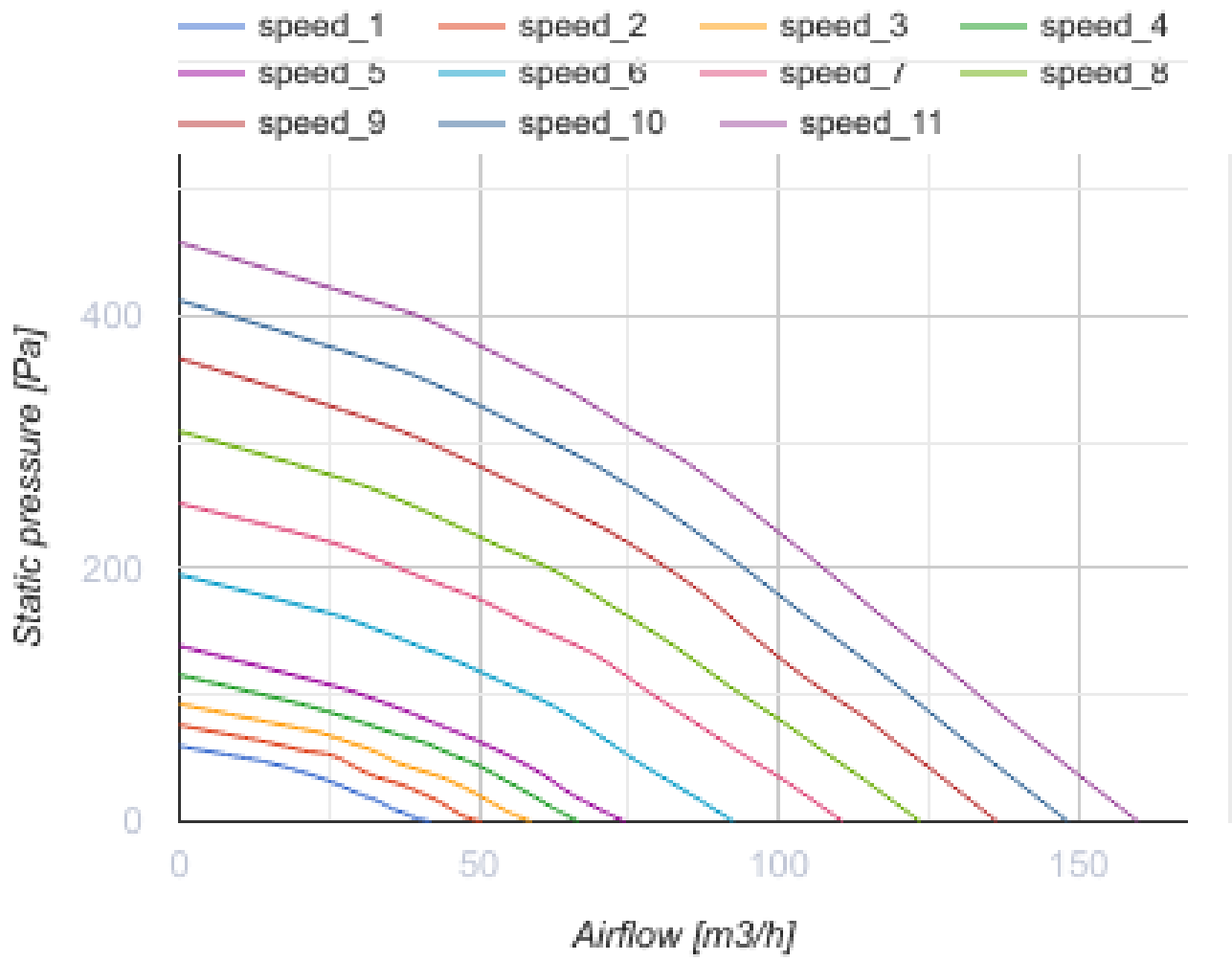

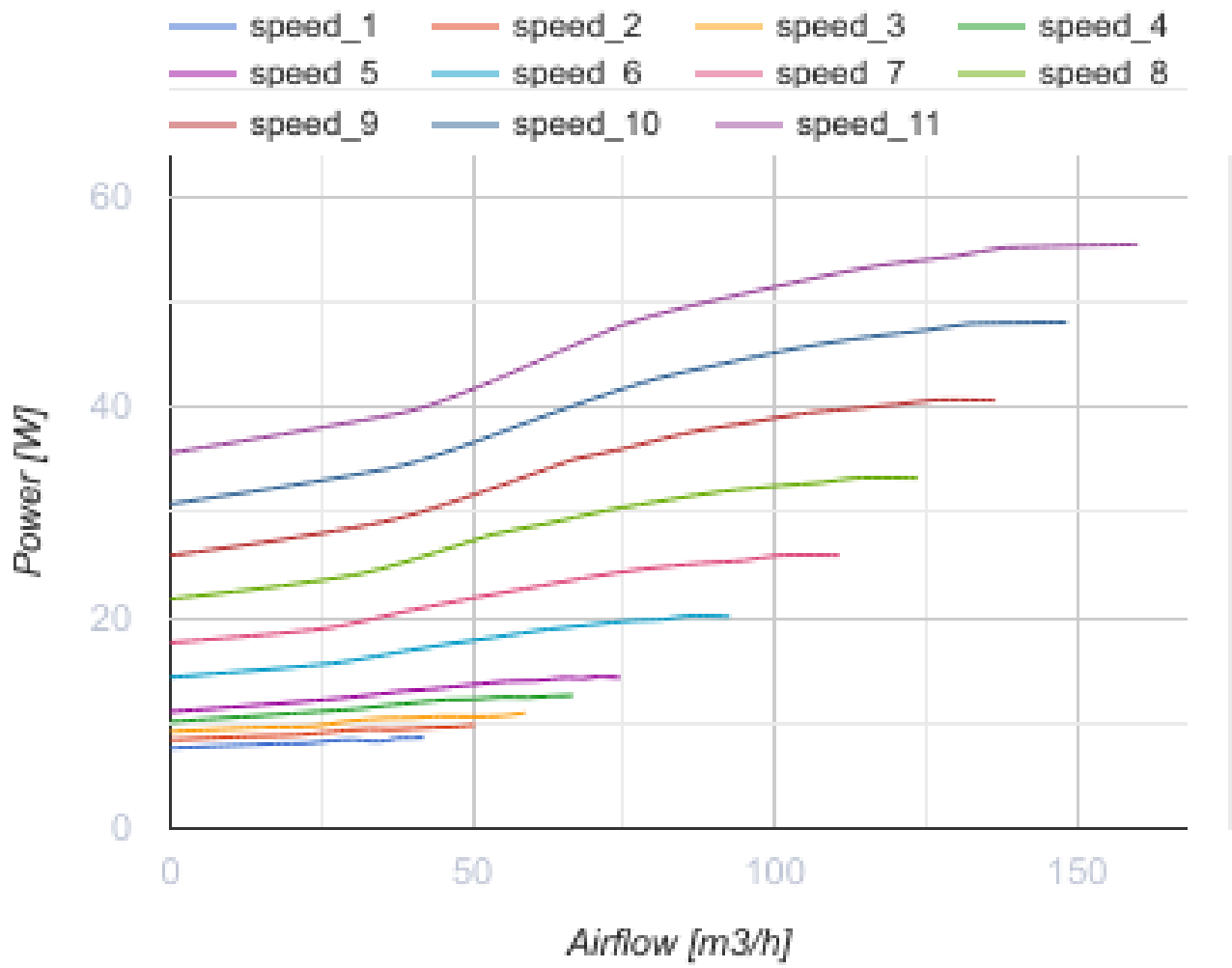

Dimensions

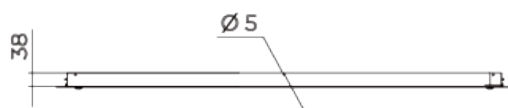
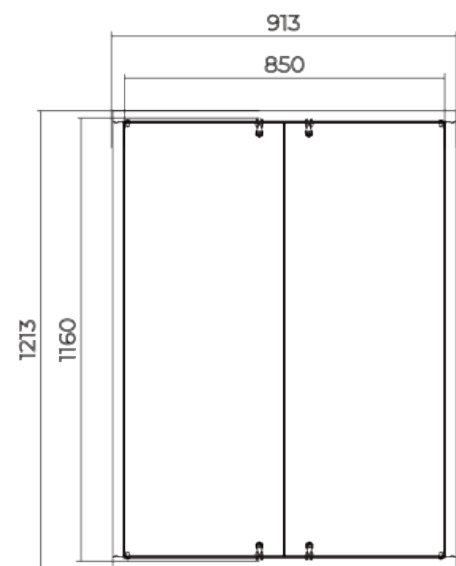
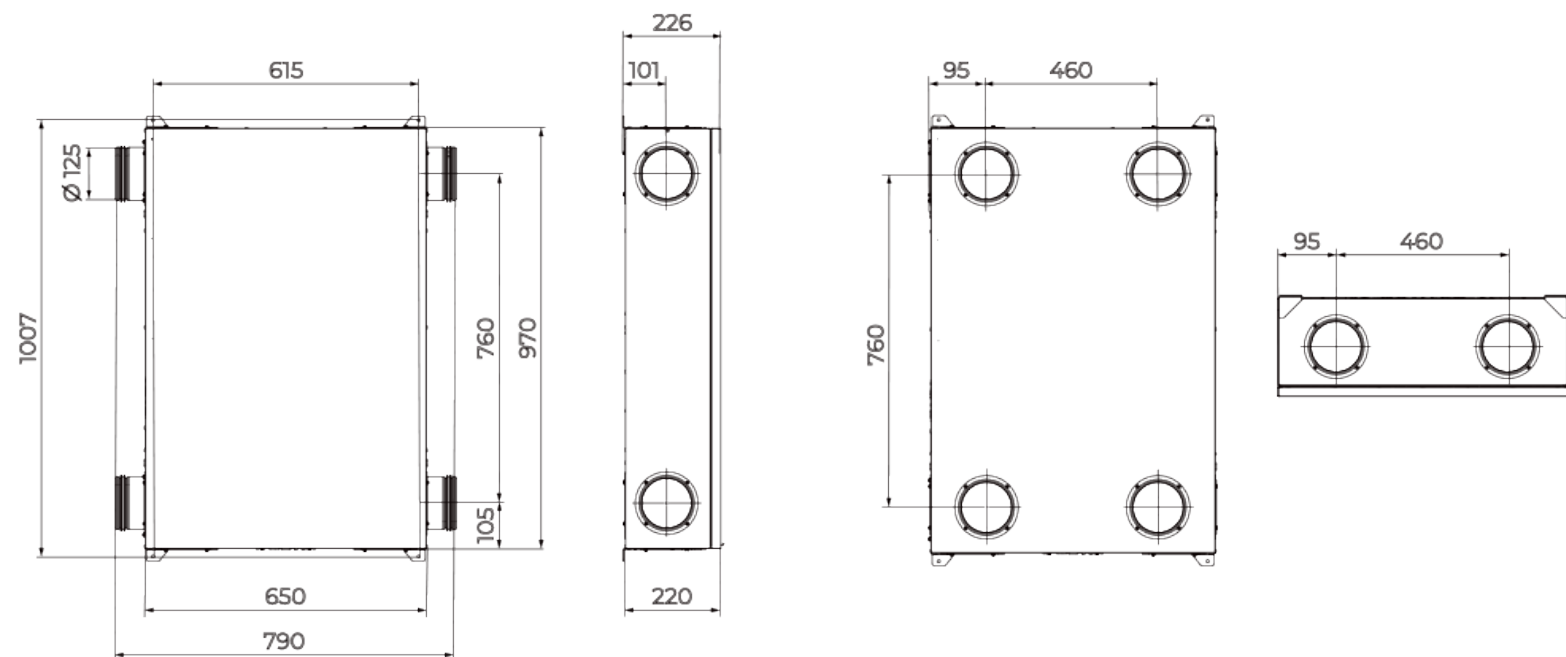

РЕВИЗИОННЫЕ ДВЕРЦЫ
RTMS2 850x1160

Ecodesign

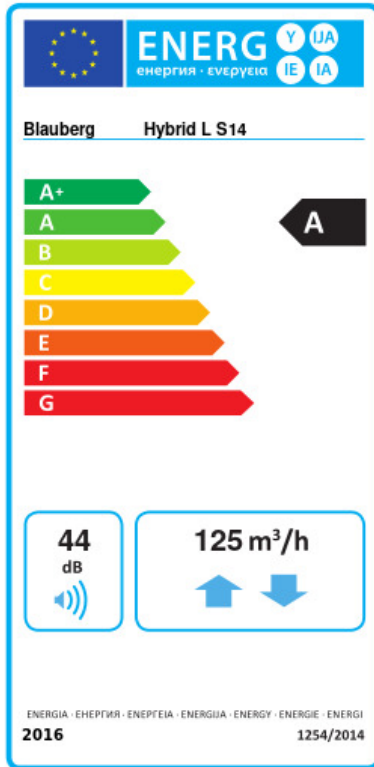

| | | | | | | |
|---|----------------------|----|---------|---|-------|---|
| Trademark | Blauberg | | | | | |
| Model | Hybrid L S14 | | | | | |
| Specific energy consumption (SEC) (kWh/(m ² /a)) | Cold | | Average | | Warm | |
| | -78.8 | A+ | -41 | A | -16.8 | E |
| Type of ventilation unit | Bidirectional | | | | | |
| Type of drive installed | Variable speed | | | | | |
| Type of heat recovery system | Recuperative | | | | | |
| Thermal efficiency of heat recovery (%) | 81 | | | | | |
| Maximum flow rate (m ³ /h) | 125 | | | | | |
| Electric power input (W) | 52 | | | | | |
| Reference flow rate (m ³ /s) | 0.027 | | | | | |
| Reference pressure difference (Pa) | 50 | | | | | |
| Specific power input (SPI) (W/(m ³ /h)) | 0.271 | | | | | |
| Control typology | Local demand control | | | | | |
| Maximum internal leakage rates (%) | 2.7 | | | | | |
| Maximum external leakage rates (%) | 2.7 | | | | | |
| Airflow sensitivity at +20 Pa and -20 Pa (%) | 0 | | | | | |
| Declared typology | RVU BVU | | | | | |
| Sound power level (dB(A)) | 44 | | | | | |
| The annual electricity consumption (AEC) (kWh/a) | Cold | | Average | | Warm | |
| | 725 | | 188 | | 143 | |
| The annual heating saved (AHS) (kWh/a) | Cold | | Average | | Warm | |
| | 8817 | | 4507 | | 2038 | |