

Hybrid ERV L S14

Centralised ventilation unit for small apartments

- Sound insulation
- Motor type: EC
- CO2 sensor: Optional
- VOC sensor: Optional
- PM2.5 sensor: Optional



	Unit of measurement	Hybrid ERV L S14
Speed	-	3
Minimum supply voltage	V	230
Maximum supply voltage	V	230
Power supply frequency	Hz	50/60
Unit current	A	0.5
Transported air temperature (max)	°C	40
Transported air temperature (min)	°C	-25

Dimensions

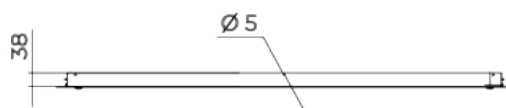
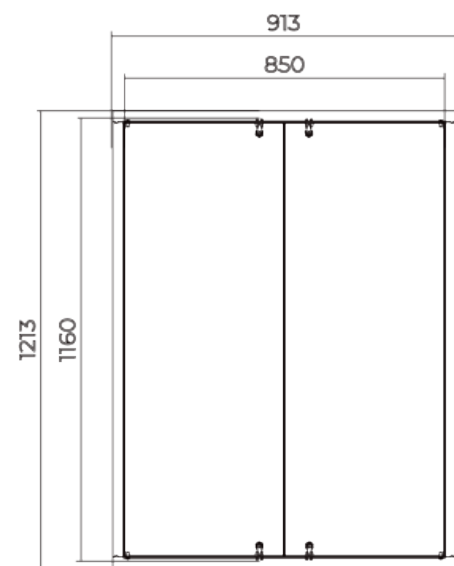
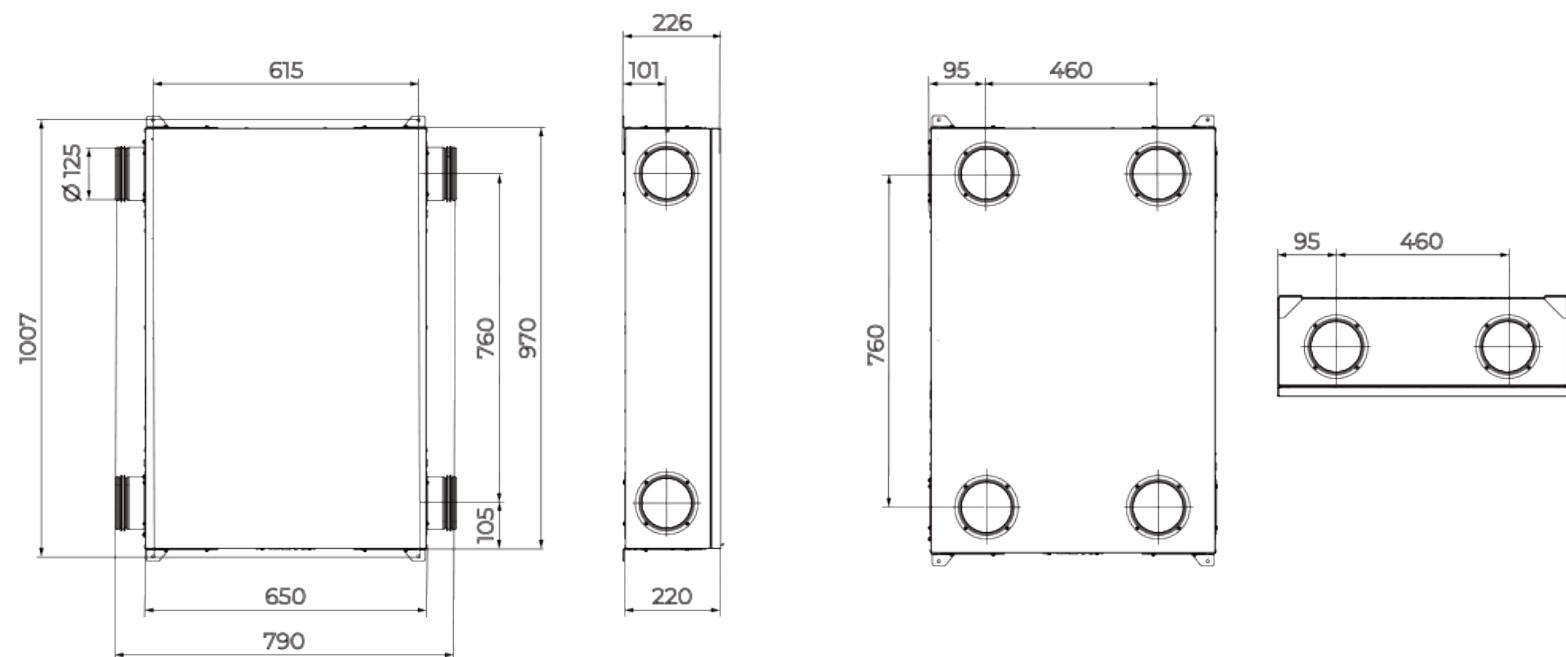

РЕВИЗИОННЫЕ ДВЕРЦЫ
RTMS2 850x1160