

Extero EC 150

Exhaust centrifugal fans with EC motor

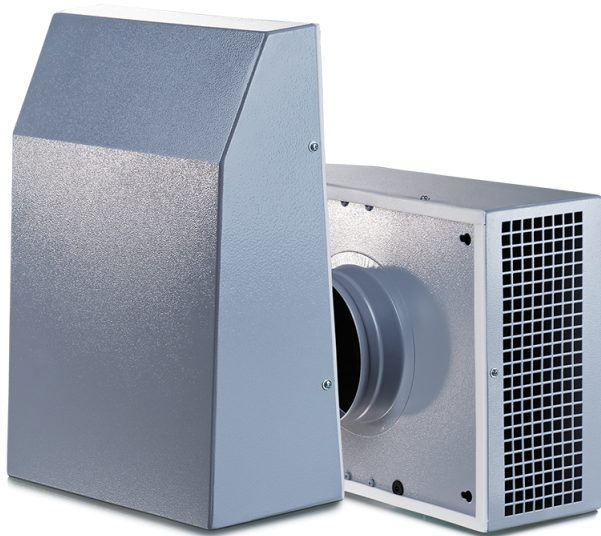

- Maximum airflow: 550
- Sound pressure level LpA at 3 m: 56
- Motor type: EC
- Impeller type: Centrifugal backward curved blades
- Casing material: Coated steel
- Installation in any position

	Unit of measurement	Extero EC 150
Connected air duct size	mm	150
Speed	-	1
Minimum supply voltage	V	230
Maximum supply voltage	V	230
Power supply frequency	Hz	50/60
Rated power	W	92
Unit current	A	0.75
Maximum airflow	m ³ /h	550
Sound pressure level LpA at 3 m	dB(A)	56
Weight	kg	4.7
Transported air temperature (max)	°C	40
Transported air temperature (min)	°C	-25
Ingress protection rating	-	IPX4
Ingress protection rating of the drive	-	IP55

Dimensions

ØD	B	H	L
150	300	400	140

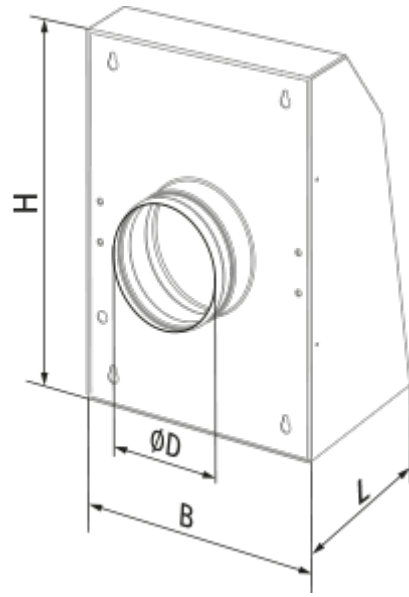

Ecodesign

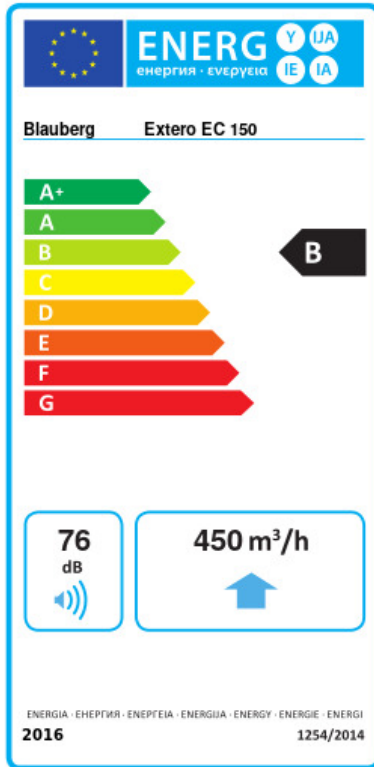

Trademark	Blaubeerg					
Model	Extero EC 150					
Specific energy consumption (SEC) (kWh/(m ² /a))	Cold	Average	Warm			
	-53.4	A+	-26.4	B	-10.9	E
Type of ventilation unit	Unidirectional					
Type of drive installed	Variable speed					
Type of heat recovery system	None					
Maximum flow rate (m ³ /h)	450					
Electric power input (W)	91					
Reference flow rate (m ³ /s)	0.088					
Reference pressure difference (Pa)	50					
Specific power input (SPI) (W/(m ³ /h))	0.145					
Control typology	Local demand control					
Maximum external leakage rates (%)	2.7					
Declared typology	RVU UVU					
Sound power level (dB(A))	76					
The annual electricity consumption (AEC) (kWh/a)	Cold	Average	Warm			
	77	77	77			
The annual heating saved (AHS) (kWh/a)	Cold	Average	Warm			
	5536	2830	1280			



Accessories

Other accessories

Name	Photo	Description
CDT E/0-10		Speed control for EC motors

Other accessories

Name	Photo	Description
TE / TI 1.5		Timers

HSE / HSI 1.5		Sensors
LSE / LSI 1.5		Sensors
IRSE / IRSI 1.5		Sensors