



Centro 150 FR1

Inline centrifugal fans

- Maximum airflow: 460
- Motor type: AC
- Control: Built-in speed controller
- Impeller type: Centrifugal backward curved blades
- Casing material: Plastic
- Installation in any position
- Cable with mains plug

	Unit of measurement	Centro 150 FR1
Connected air duct size	mm	150
Speed	-	1
Minimum supply voltage	V	220
Maximum supply voltage	V	240
Power supply frequency	Hz	50/60
Rated power	W	80
Unit current	A	0.35
Maximum airflow	m ³ /h	460
Weight	kg	2.45
Transported air temperature (max)	°C	55
Transported air temperature (min)	°C	-25
Ingress protection rating	-	IPX4

Dimensions

ØD	ØD1	B	L	L1	L2	L3
150/160	300	310	286	30	30	30

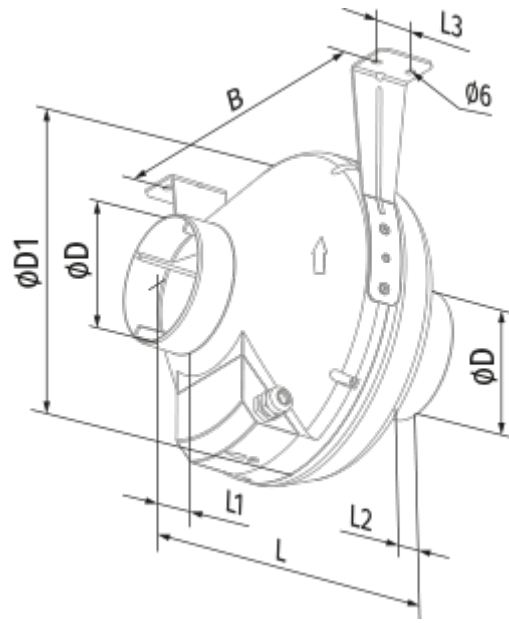



Ecodesign



Trademark	Blauberg					
Model	Centro 150 FR1					
Specific energy consumption (SEC) (kWh/(m ² /a))	Cold		Average		Warm	
	53.7	A+	26.6	B	11.1	E
Type of ventilation unit	Unidirectional					
Type of drive installed	Variable speed					
Type of heat recovery system	None					
Maximum flow rate (m ³ /h)	400					
Electric power input (W)	80					
Reference flow rate (m ³ /s)	0.078					
Reference pressure difference (Pa)	50					
Specific power input (SPI) (W/(m ³ /h))	0.129					
Control typology	Local demand control					
Maximum external leakage rates (%)	2.7					
Sound power level (dB(A))	66					
Declared typology	RVU UVU					
The annual electricity consumption (AEC) (kWh/a)	Cold		Average		Warm	
	68		68		68	
The annual heating saved (AHS) (kWh/a)	Cold		Average		Warm	
	5536		2830		1280	

Accessories

Other accessories

Name	Photo	Description
CDT E1.8		Thyristor speed controller
CDP-2/5		Multi-speed switch
CDP-2/10		Multi-speed switch