



Bravo Chrome 150

Extract fans

- Sound pressure level LpA at 3 m: 39
- Backdraft protection: Backdraft damper

	Unit of measurement	Bravo Chrome 150
Connected air duct size	mm	150
Minimum supply voltage	V	220
Maximum supply voltage	V	240
Power supply frequency	Hz	50
Rated power	W	24
Unit current	A	0.13
Maximum airflow	m ³ /h	305
Sound pressure level LpA at 3 m	dB(A)	39
Ingress protection rating	-	IP34
Impeller material	-	Plastic
Article	-	8006111





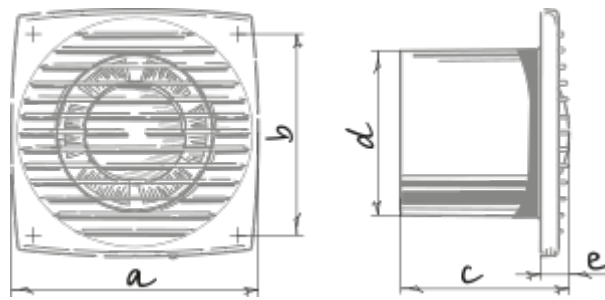



Dimensions

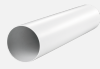

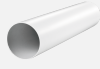

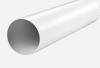

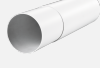



a	b	c	Ø d	e
205	174	124	150	19



Accessories

Air distribution

Name	Photo	Description
BlauPlast RR 150/1		Round duct
BlauPlast RR 150/1.5		Round duct
BlauPlast RR 150/0.5		Round duct
BlauPlast RR 150/0.35		Round duct
BlauPlast RR 150/2.5		Round duct
BlauPlast RR 150/2		Round duct
BlauPlast RTR 150/0.5-1		Round telescopic duct
BlauPlast RTR 150/0.35-0.5		Round telescopic duct
BlauPlast RSV 150		Flexible duct connector
BlauPlast RB 150/90°		Bend 90°

BlauPlast RRT 150		T-joint for round ducts
BlauPlast WP 150		Wall plate for round ducts
BlauPlast RV 150		Round duct connector
BlauPlast RVK 150		Connector with backdraft damper for round ducts
BlauPlast RVPK 150		Round duct connector with a plate and a gravity backdraft damper
BlauPlast RVP 150		Round duct connector with plate
BlauPlast US-90° 150/204x60		Bend
BlauPlast US-90° 150/220x90		Bend
BlauPlast UBS 150/220x90		Connector
BlauPlast RH 150		Round duct holder
BlauFlex Iso N 152/7.6		Flexible air ducts BlauFlex