

Box-R 200 V2

Inline centrifugal fans





- Maximum airflow: 1200
- Sound pressure level LpA at 3 m: 48
- Motor type: AC
- Impeller type: Centrifugal backward curved blades
- Casing material: Coated steel
- Installation in any position

	Unit of measurement	Box-R 200 V2	
Connected air duct size	mm	200	
Speed	-	2	
Minimum supply voltage	V	230	
Maximum supply voltage	V	230	
Power supply frequency	Hz	50	
Rated power	W	103	142
Unit current	A	0.45	0.63
Maximum airflow	m ³ /h	770	1200
Sound pressure level LpA at 3 m	dB(A)	46	48
Weight	kg	8.8	
Transported air temperature (max)	°C	50	
Ingress protection rating	-	IPX4	
Ingress protection rating of the drive	-	IP44	



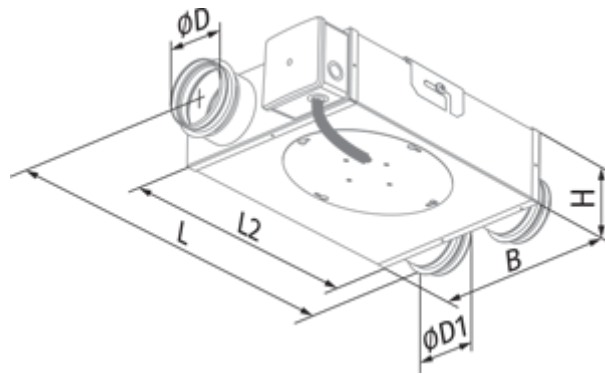

Dimensions

ØD	ØD1	B	H	L	L2
198	198	362	222	494	397



CDP-3/5		Multi-speed switch
-------------------------	---	--------------------

Humidity sensors

Name	Photo	Description
TE / TI 1.5		Timers
HSE / HSI 1.5		Sensors
LSE / LSI 1.5		Sensors
IRSE / IRSI 1.5		Sensors