

Box-R 150

Centrifugal inline fans

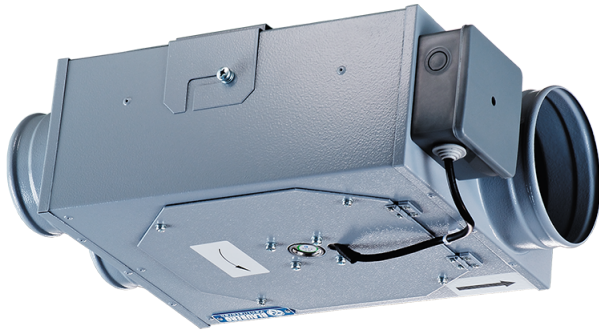

- Maximum airflow: 536
- Sound pressure level LpA at 3 m: 46
- Motor type: AC
- Impeller type: Centrifugal backward curved blades
- Casing material: Coated steel
- Installation in any position

	Unit of measurement	Box-R 150
Connected air duct size	mm	150
Speed	-	1
Minimum supply voltage	V	230
Maximum supply voltage	V	230
Power supply frequency	Hz	50
Rated power	W	113
Unit current	A	0.52
Maximum airflow	m ³ /h	536
Sound pressure level LpA at 3 m	dB(A)	46
Weight	kg	7.1
Transported air temperature (max)	°C	50
Ingress protection rating	-	IPX4
Ingress protection rating of the drive	-	IP44

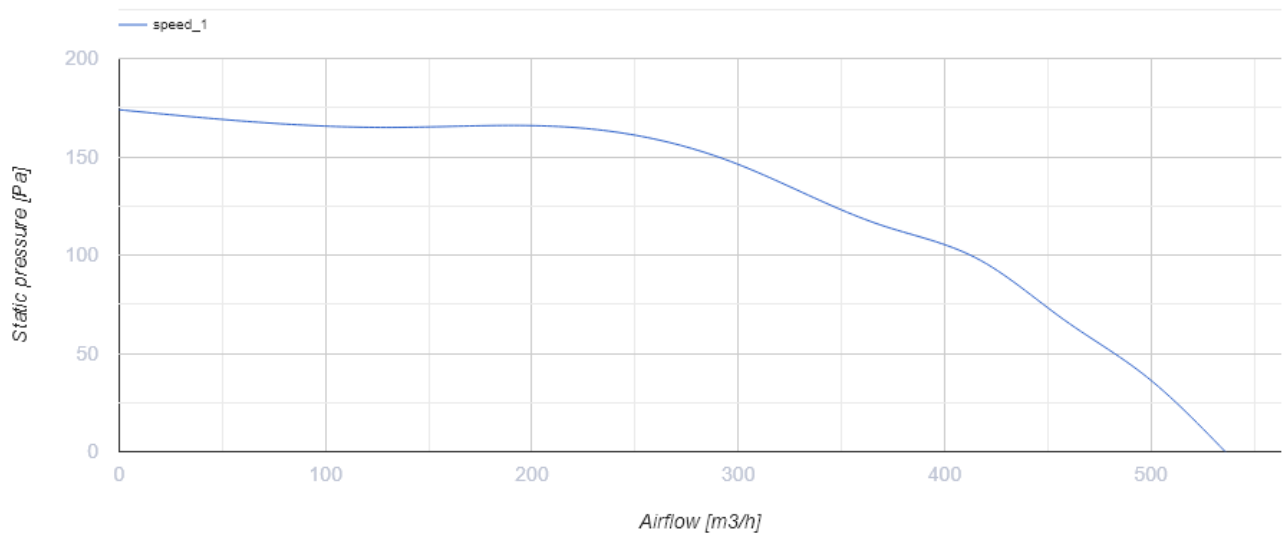

Dimensions

ØD	ØD1	B	H	L	L2
149	149	340	207	447	350

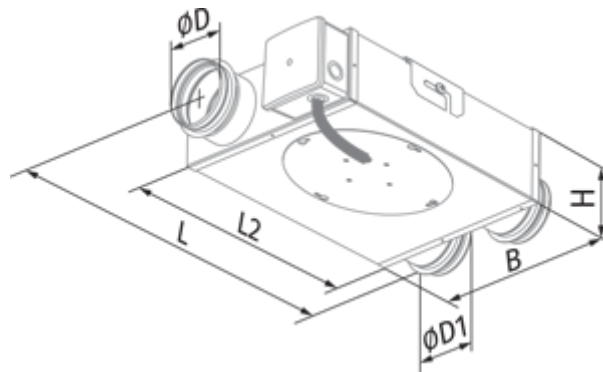

Ecodesign

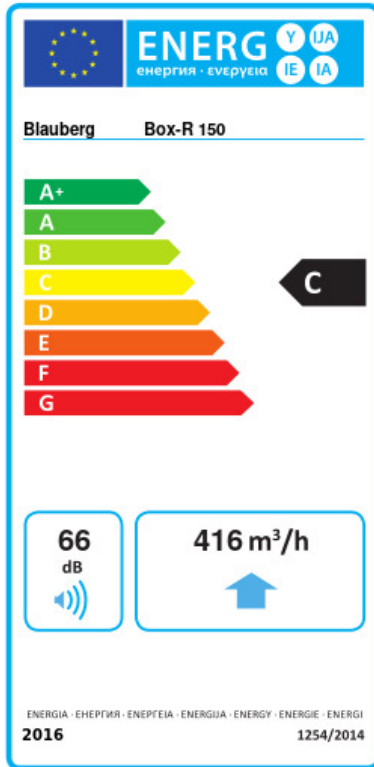





Trademark	Blaubeerg					
Model	Box-R 150					
Specific energy consumption (SEC) (kWh/(m ² /a))	Cold		Average		Warm	
	-51	A+	-24	C	-8.5	F
Type of ventilation unit	Unidirectional					
Type of drive installed	Variable speed					
Type of heat recovery system	None					
Maximum flow rate (m ³ /h)	416					
Electric power input (W)	102.8					
Reference flow rate (m ³ /s)	0.081					
Reference pressure difference (Pa)	50					
Specific power input (SPI) (W/(m ³ /h))	0.326					
Control typology	Local demand control					
Maximum external leakage rates (%)	2.7					
Declared typology	RVU UVU					
Sound power level (dB(A))	66					
The annual electricity consumption (AEC) (kWh/a)	Cold		Average		Warm	
	173		173		173	
The annual heating saved (AHS) (kWh/a)	Cold		Average		Warm	
	5536		2830		1280	

Accessories

Other accessories

Name	Photo	Description
MLCD E2		Room temperature regulator
CDP-2/5		Multi-speed switch
CDP-3/5		Multi-speed switch

Other accessories

Name	Photo	Description
TE / TI 1.5		Timers
HSE / HSI 1.5		Sensors
LSE / LSI 1.5		Sensors
IRSE / IRSI 1.5		Sensors