

## Box-I EC 80x50-3

Centrifugal inline fans with backward curved blades in sound-insulated casings with EC-motors



- Maximum airflow: 8395
- Sound pressure level LpA at 3 m: 43
- Sound insulation
- Motor type: EC
- Impeller type: Centrifugal backward curved blades
- Casing material: Galvanized steel
- Installation in any position

	Unit of measurement	Box-I EC 80x50-3
Connected air duct size	mm	800x500
Speed	-	1
Minimum supply voltage	V	400
Maximum supply voltage	V	400
Power supply frequency	Hz	50/60
Rated power	W	2025
Unit current	A	2.01
Maximum airflow	m <sup>3</sup> /h	8395
Sound pressure level LpA at 3 m	dB(A)	43
Weight	kg	108.4
Transported air temperature (max)	°C	50
Transported air temperature (min)	°C	-25
Ingress protection rating	-	IPX4
Ingress protection rating of the drive	-	IP54

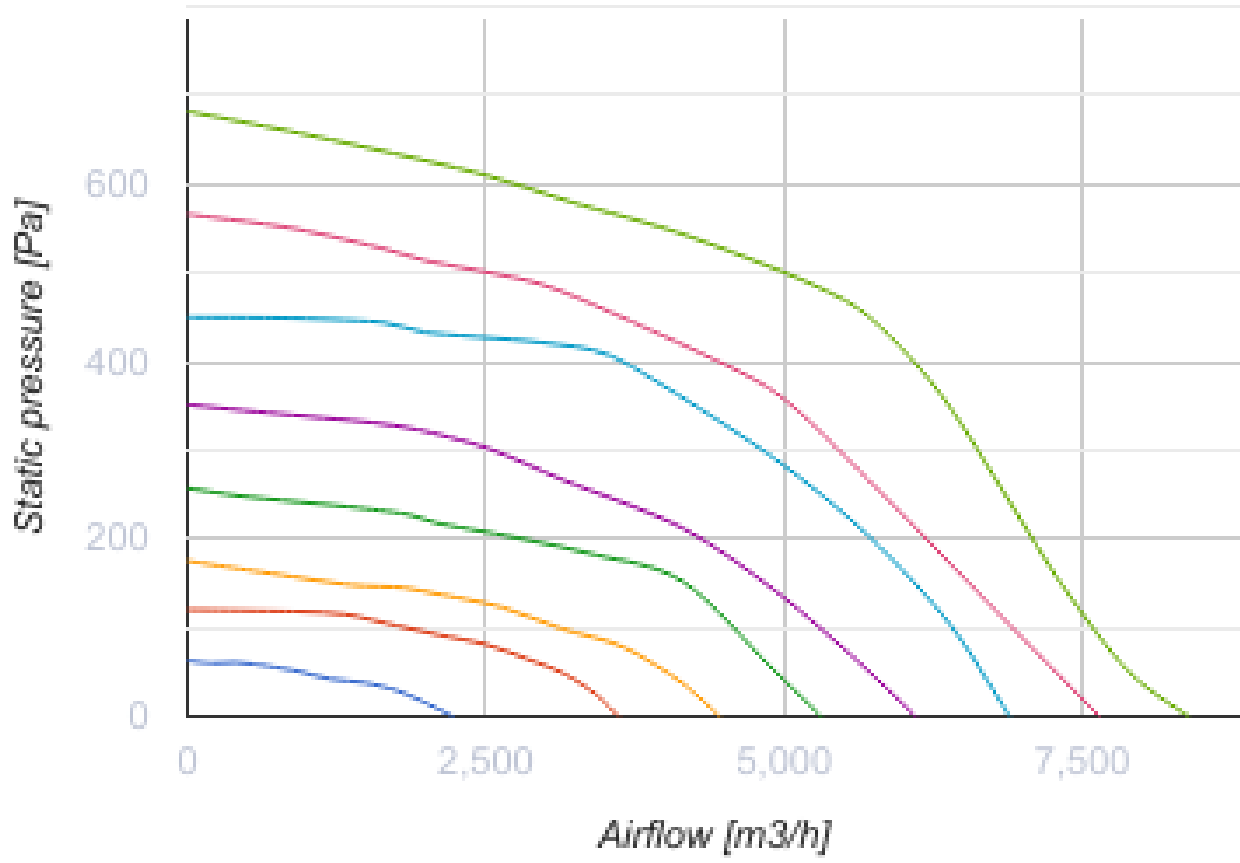

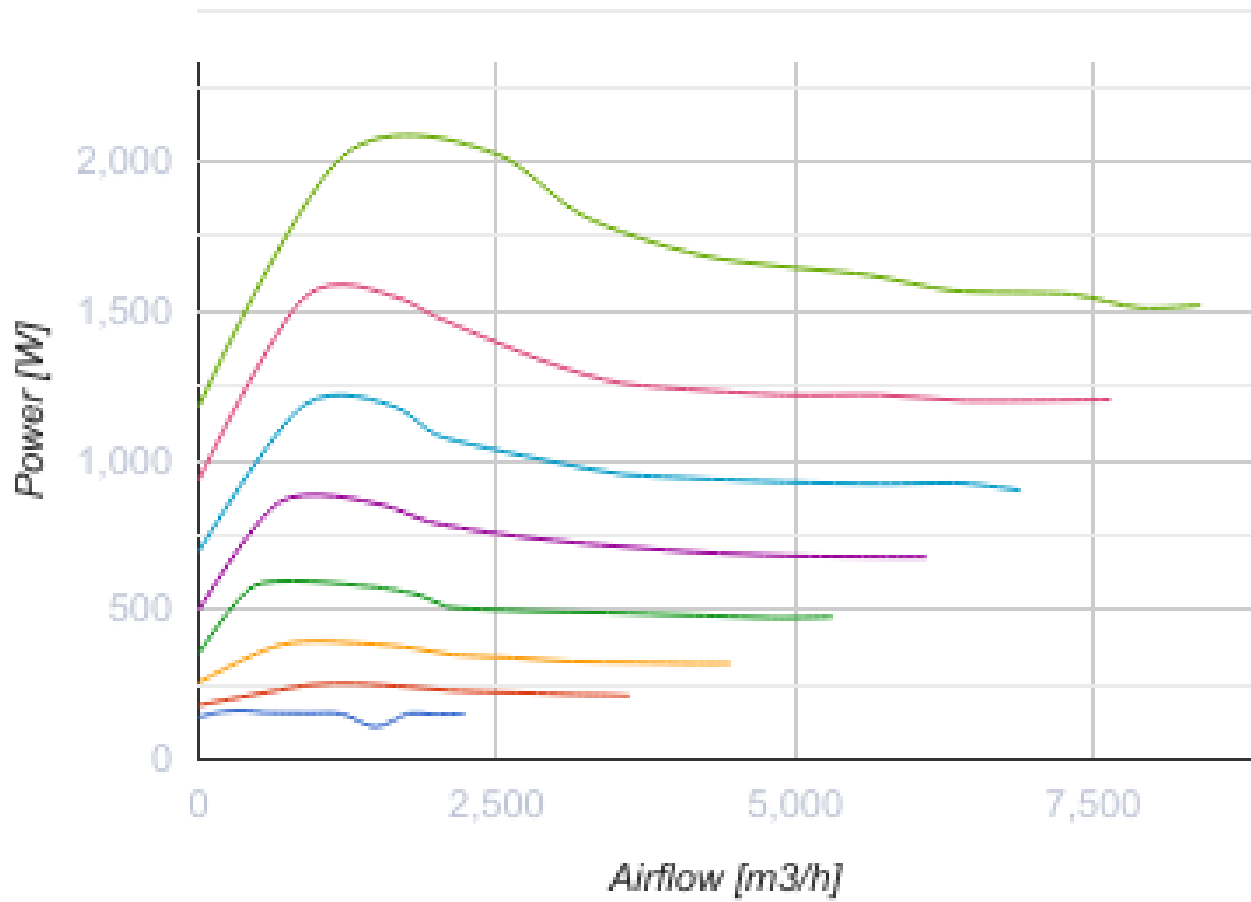

## Dimensions

B	B1	H	H1	L
983	800	814	500	937

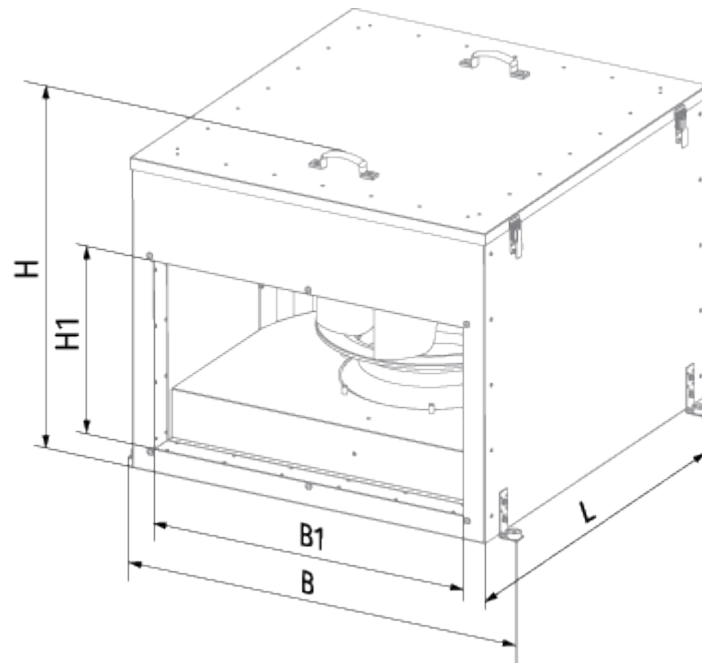

## Ecodesign

Trademark	Blauberg
Model	Box-I EC 80x50-3
Type of ventilation unit	Unidirectional
Type of drive installed	Integrated VSD
Type of heat recovery system	None
Nominal flow rate (m <sup>3</sup> /s)	1.561
Nominal external pressure (Pa)	460
Maximum external leakage rates (%)	2.7
Static efficiency (%)	48.5
Declared typology	NRVU UVU
Sound power level (dB(A))	63
Effective electric power input (kW)	1.621

## Accessories

### Other accessories

Name	Photo	Description
<a href="#">CDT E/0-10</a>		Speed control for EC motors