

Box-I EC 60x35-1

Centrifugal inline fans with backward curved blades in sound-insulated casings with EC-motors



- Sound pressure level LpA at 3 m: 38
- Sound-insulated casing
- Impeller type: Centrifugal impeller with backward curved blades
- Casing material: Galvanized steel
- Installation in any position

	Unit of measurement	Box-I EC 60x35-1
Connected air duct size	mm	600x350
Phases	-	1
Minimum supply voltage	V	230
Maximum supply voltage	V	230
Power supply frequency	Hz	50/60
Rated power	W	361
Unit current	A	2.62
Maximum airflow	m ³ /h	2815
Rotation speed at 50hz	-	2000
Sound pressure level LpA at 3 m	dB(A)	38
Weight	kg	56.6
Transported air temperature (max)	°C	50
Transported air temperature (min)	°C	-25
Ingress protection rating	-	IPX4
Ingress protection rating of the drive	-	IP54
Impeller material	-	Aluminium
Article	-	8061950

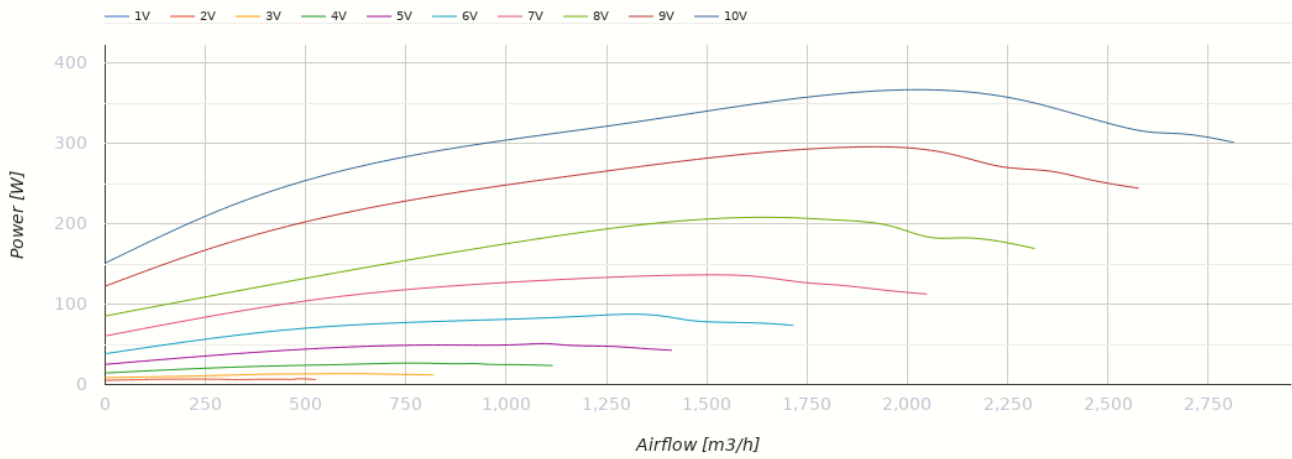
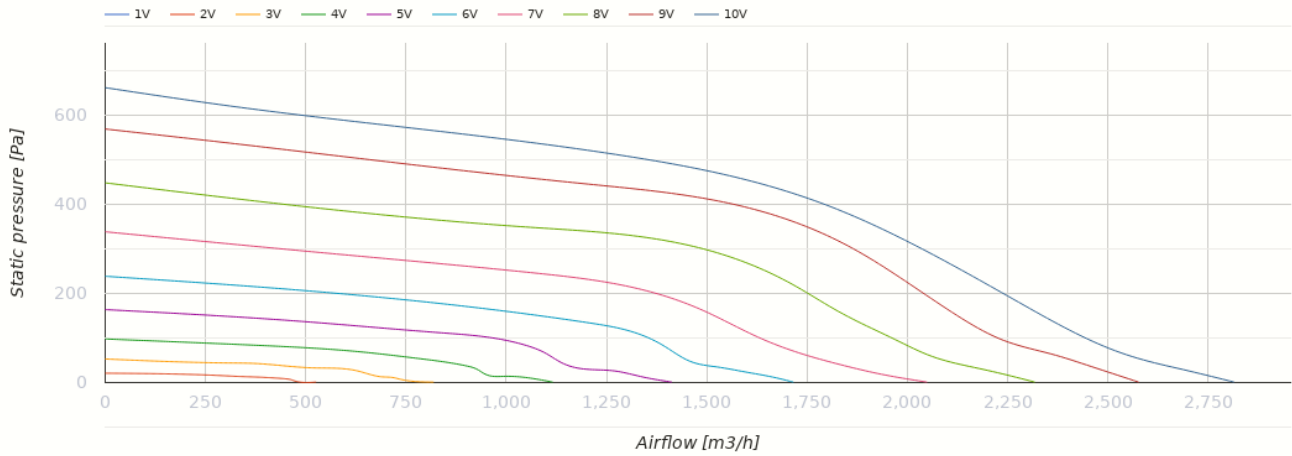

Dimensions

H	H1	H3	L	L1	W	W1	W2	W3
350	370	664	752	450	600	620	783	755

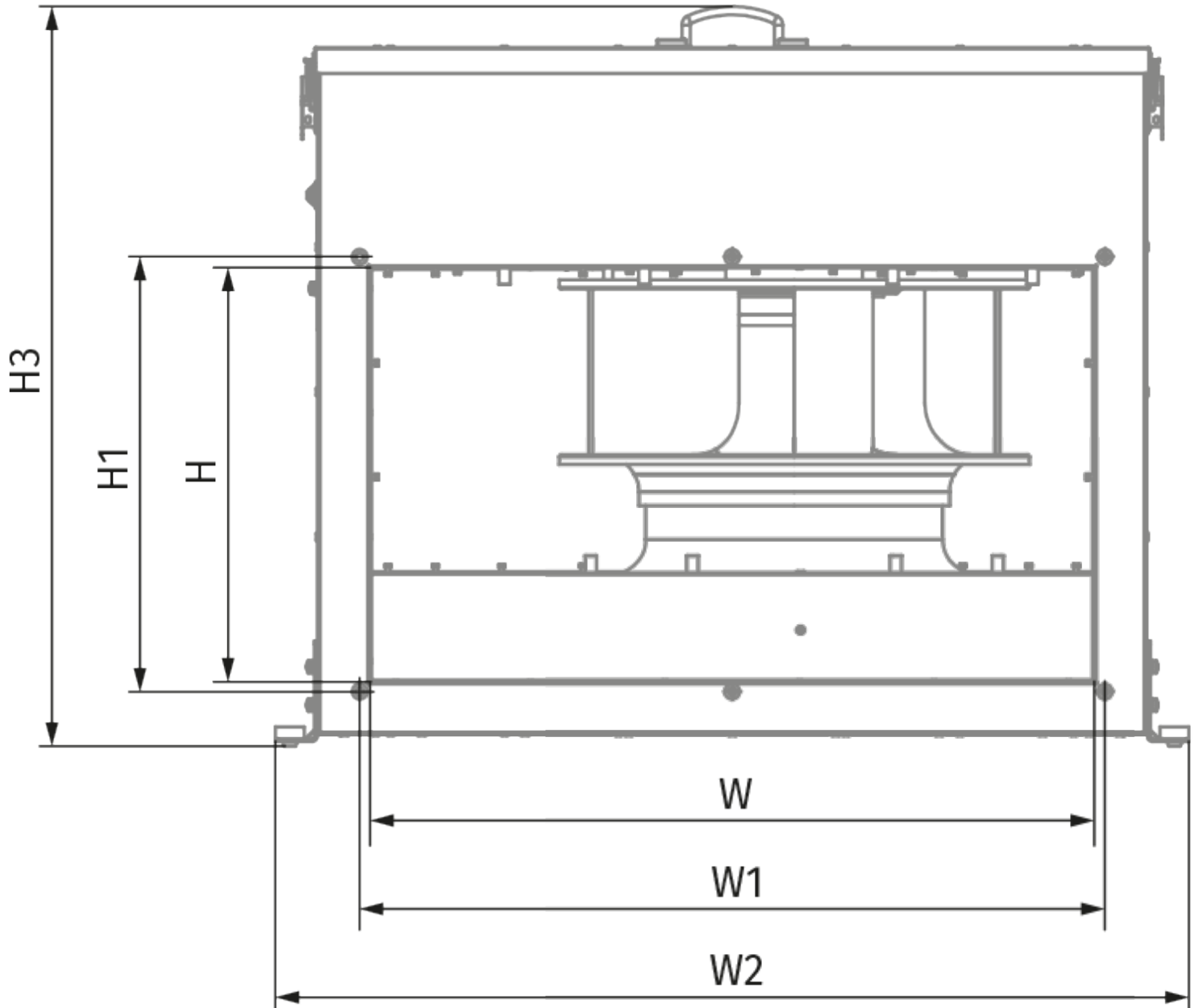

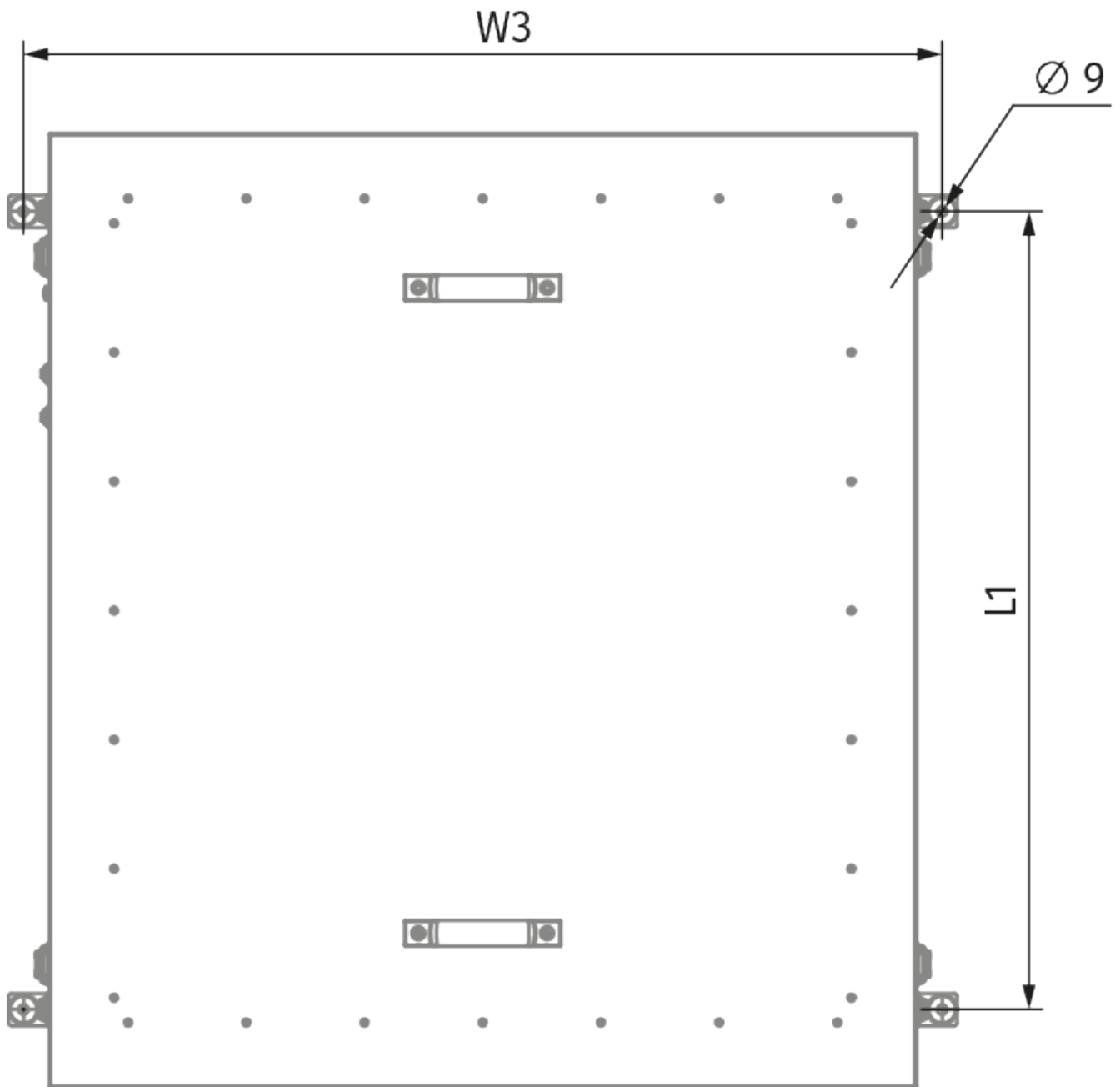

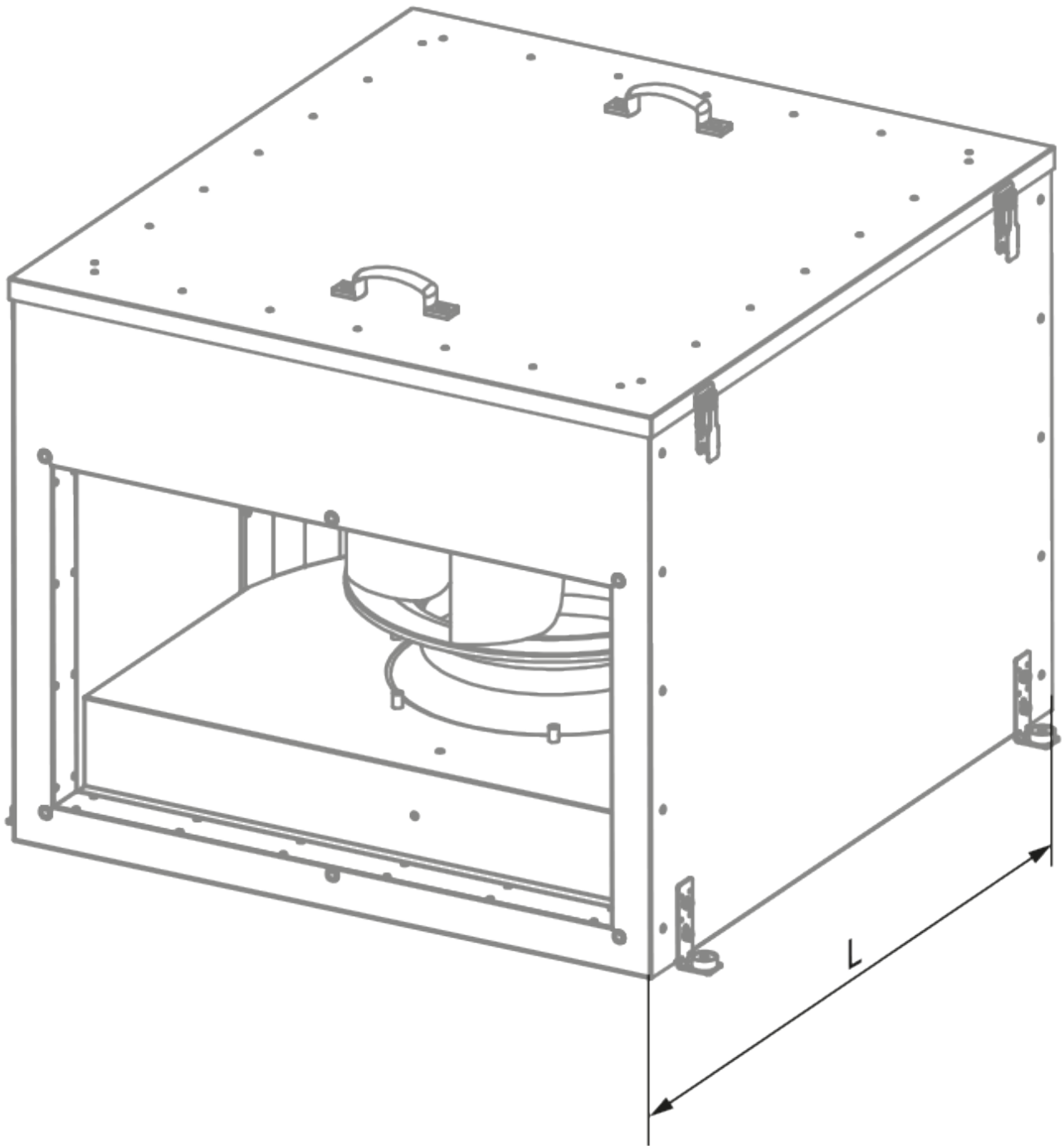

Ecodesign

Trademark	Blauberg
Model	Box-I EC 60x35-1
Type of ventilation unit	Unidirectional
Type of drive installed	Integrated VSD
Type of heat recovery system	None
Nominal external pressure (Pa)	445
Maximum external leakage rates (%)	2.7
Static efficiency (%)	65.3
Sound power level (dB(A))	58
Effective electric power input (kW)	0.263
Declared typology	NRVU UVU

Accessories

EC motors regulators

Name	Photo	Description
CDT E/0-10		Speed control for EC motors