

Box-I EC 40x20-1 max

Centrifugal fans in sound-insulated casing with EC motor



- Maximum airflow: 1190
- Sound pressure level LpA at 3 m: 30
- Sound insulation
- Motor type: EC
- Impeller type: Centrifugal backward curved blades
- Casing material: Galvanized steel
- Installation in any position

	Unit of measurement	Box-I EC 40x20-1 max
Connected air duct size	mm	400x200
Speed	-	1
Minimum supply voltage	V	230
Maximum supply voltage	V	230
Power supply frequency	Hz	50/60
Rated power	W	192
Unit current	A	1.43
Maximum airflow	m ³ /h	1190
Sound pressure level LpA at 3 m	dB(A)	30
Weight	kg	16.8
Transported air temperature (max)	°C	50
Transported air temperature (min)	°C	-25
Ingress protection rating	-	IPX4
Ingress protection rating of the drive	-	IP54

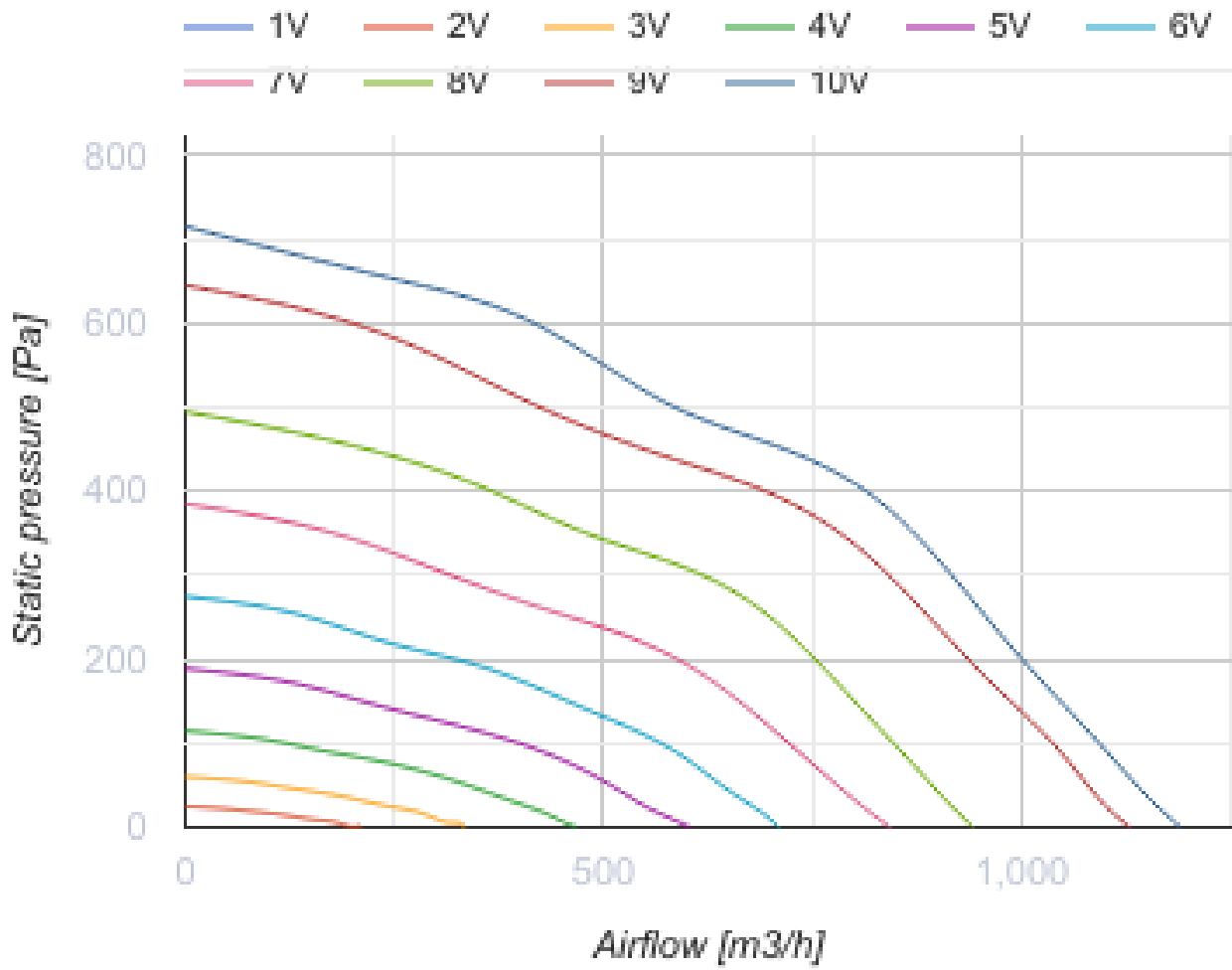

Dimensions

B	B1	H	H1	L
464	400	322	200	460

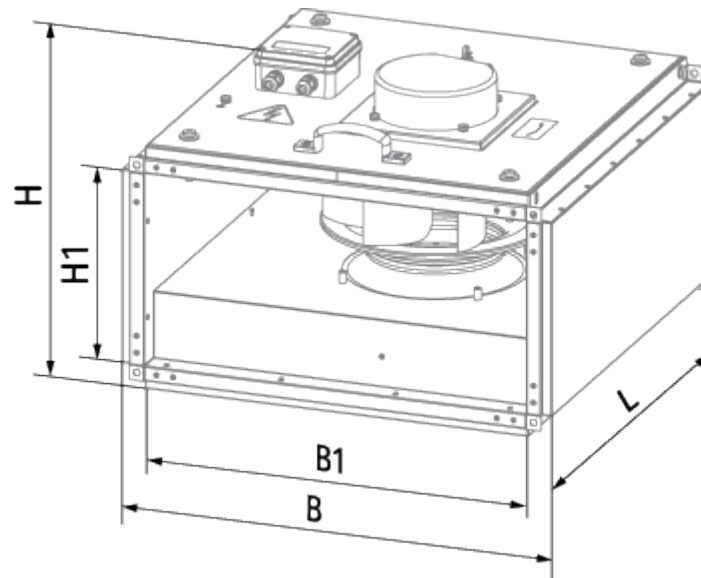

Ecodesign

Trademark	Blauberg
Model	Box-I EC 40x20-1 max
Type of ventilation unit	Unidirectional
Type of drive installed	Integrated VSD
Type of heat recovery system	None
Nominal flow rate (m ³ /s)	0.161
Nominal external pressure (Pa)	504
Maximum external leakage rates (%)	2.7
Static efficiency (%)	54.2
Declared typology	NRVU UVU
Sound power level (dB(A))	50
Effective electric power input (kW)	0.174

Accessories

EC motors regulators

Name	Photo	Description
CDT E/0-10		Speed control for EC motors