



Box-I EC

100x50-3 max

Centrifugal fans in sound-insulated casing with EC motor

- Maximum airflow: 11190
- Sound pressure level LpA at 3 m: 47
- Sound insulation
- Motor type: EC
- Impeller type: Centrifugal backward curved blades
- Casing material: Galvanized steel
- Installation in any position

	Unit of measurement	Box-I EC 100x50-3 max
Connected air duct size	mm	1000x500
Speed	-	1
Minimum supply voltage	V	400
Maximum supply voltage	V	400
Power supply frequency	Hz	50/60
Rated power	W	3429
Unit current	A	5
Maximum airflow	m ³ /h	11190
Sound pressure level LpA at 3 m	dB(A)	47
Weight	kg	130
Transported air temperature (max)	°C	50
Transported air temperature (min)	°C	-25
Ingress protection rating	-	IPX4
Ingress protection rating of the drive	-	IP54

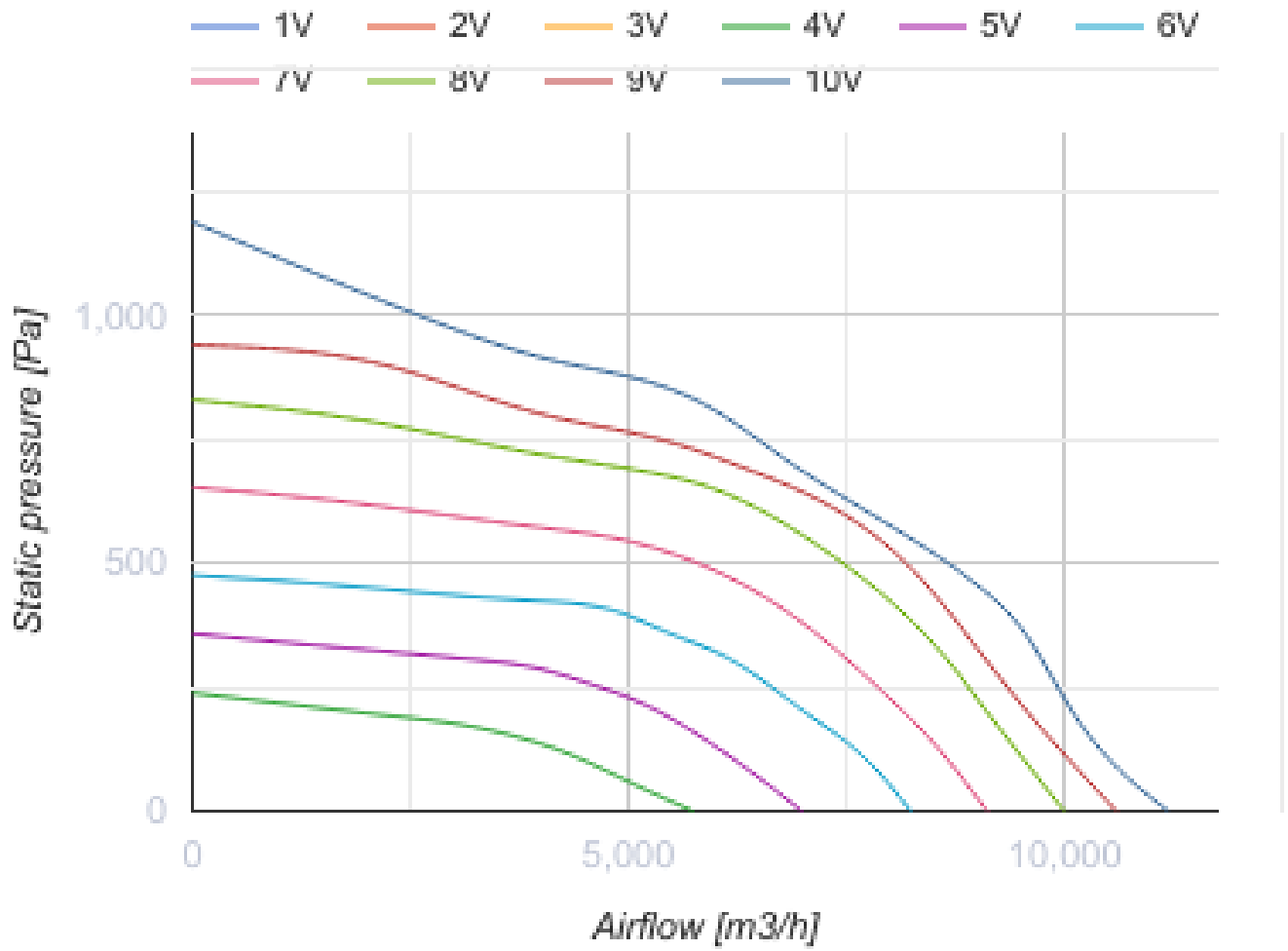

Dimensions

B	B1	H	H1	L
1183	1000	814	500	1052

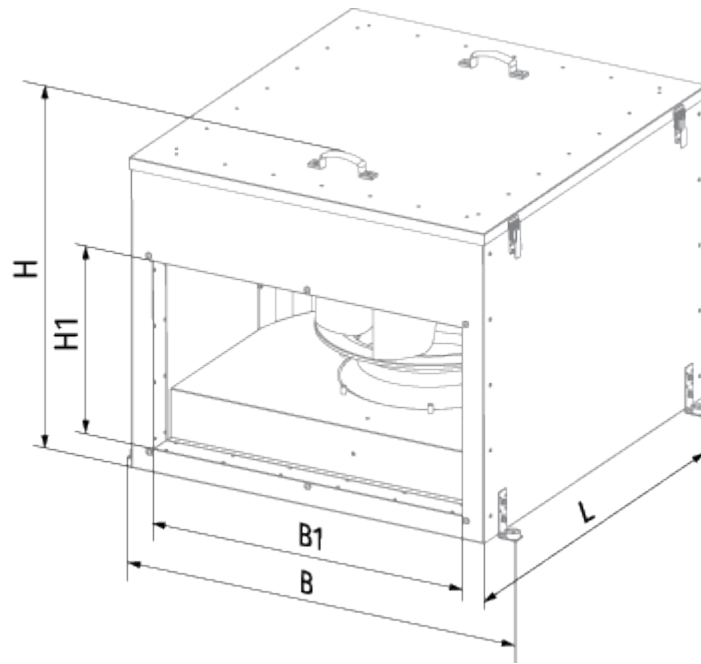

Ecodesign

Trademark	Blauberg
Model	Box-I EC 100x50-3 max
Type of ventilation unit	Unidirectional
Type of drive installed	Integrated VSD
Type of heat recovery system	None
Nominal flow rate (m ³ /s)	1.509
Nominal external pressure (Pa)	362
Maximum external leakage rates (%)	2.7
Static efficiency (%)	62.3
Declared typology	NRVU UVU
Sound power level (dB(A))	67
Effective electric power input (kW)	0.974

Accessories

EC motors regulators

Name	Photo	Description
CDT E/0-10		Speed control for EC motors