

Box-I 60x30 4E

Centrifugal fans in sound-insulated casing for rectangular ducts



- Maximum airflow: 2470
- Sound pressure level LpA at 3 m: 46
- Sound insulation
- Motor type: AC
- Impeller type: Centrifugal backward curved blades
- Casing material: Galvanized steel
- Installation in any position

	Unit of measurement	Box-I 60x30 4E
Connected air duct size	mm	600x300
Speed	-	1
Minimum supply voltage	V	220
Maximum supply voltage	V	240
Power supply frequency	Hz	50/60
Rated power	W	220
Unit current	A	0.9
Maximum airflow	m ³ /h	2470
Sound pressure level LpA at 3 m	dB(A)	46
Weight	kg	43.5
Transported air temperature (max)	°C	45
Transported air temperature (min)	°C	-25
Ingress protection rating	-	IPX4
Ingress protection rating of the drive	-	IP44

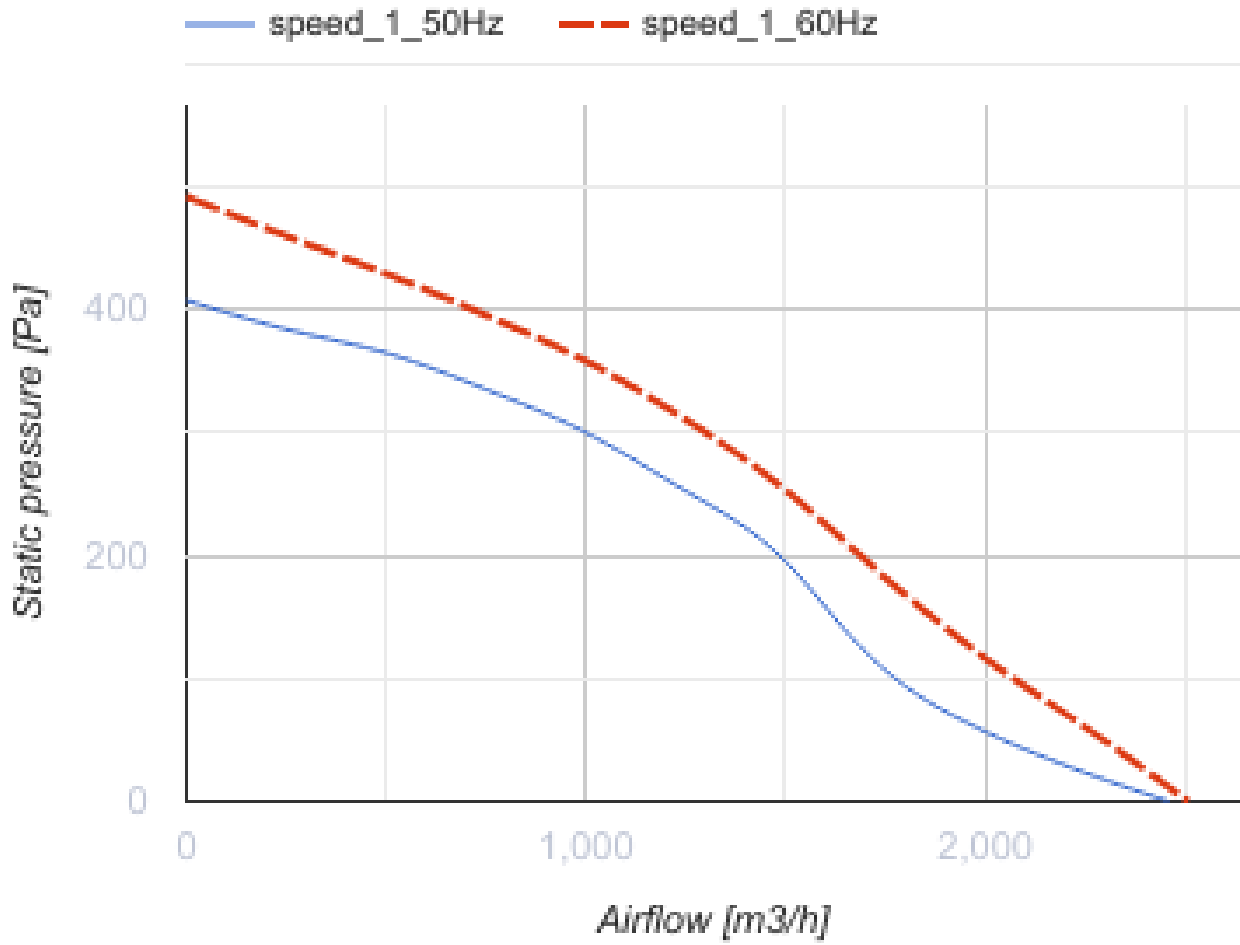

Dimensions

B	B1	B2	B3	H	H1	H2	H3	L
600	620	640	700	300	320	340	460	680

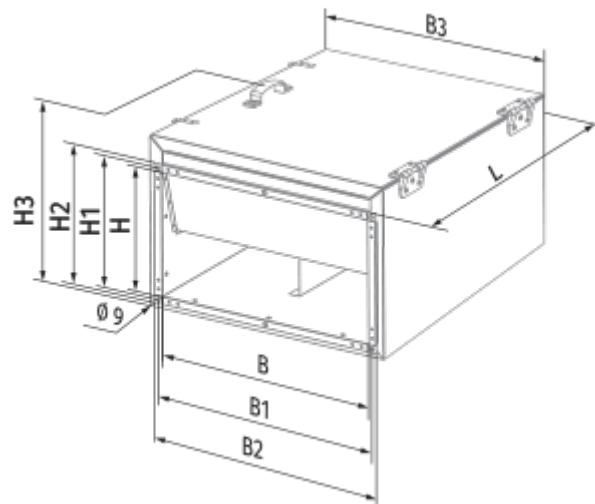

Ecodesign

Trademark	Blauberg
Model	Box-I 60x30 4E
Type of ventilation unit	Unidirectional
Type of drive installed	External MSD or VSD
Type of heat recovery system	None
Nominal flow rate (m ³ /s)	0.271
Nominal external pressure (Pa)	300
Maximum external leakage rates (%)	2.7
Static efficiency (%)	39.6
Declared typology	NRVU UVU
Sound power level (dB(A))	67
Effective electric power input (kW)	0.21

Accessories

Thyristor speed controllers

Name	Photo	Description
CDT E1.8		Thyristor speed controller