

Box-F 600x300 4E

Centrifugal inline fans with forward curved blades



- Sound pressure level LpA at 3 m: 59
- Impeller type: Centrifugal impeller with forward curved blades
- Casing material: Galvanized steel
- Installation in any position

	Unit of measurement	Box-F 600x300 4E
Connected air duct size	mm	600x300
Phases	-	1
Minimum supply voltage	V	230
Maximum supply voltage	V	230
Power supply frequency	Hz	50
Rated power	W	1240
Unit current	A	6.45
Maximum airflow	m ³ /h	2950
Rotation speed at 50hz	-	1360
Sound pressure level LpA at 3 m	dB(A)	59
Weight	kg	35
Transported air temperature (max)	°C	50
Transported air temperature (min)	°C	-25
Ingress protection rating	-	IPX4
Ingress protection rating of the drive	-	IP44
Impeller material	-	Galvanized steel

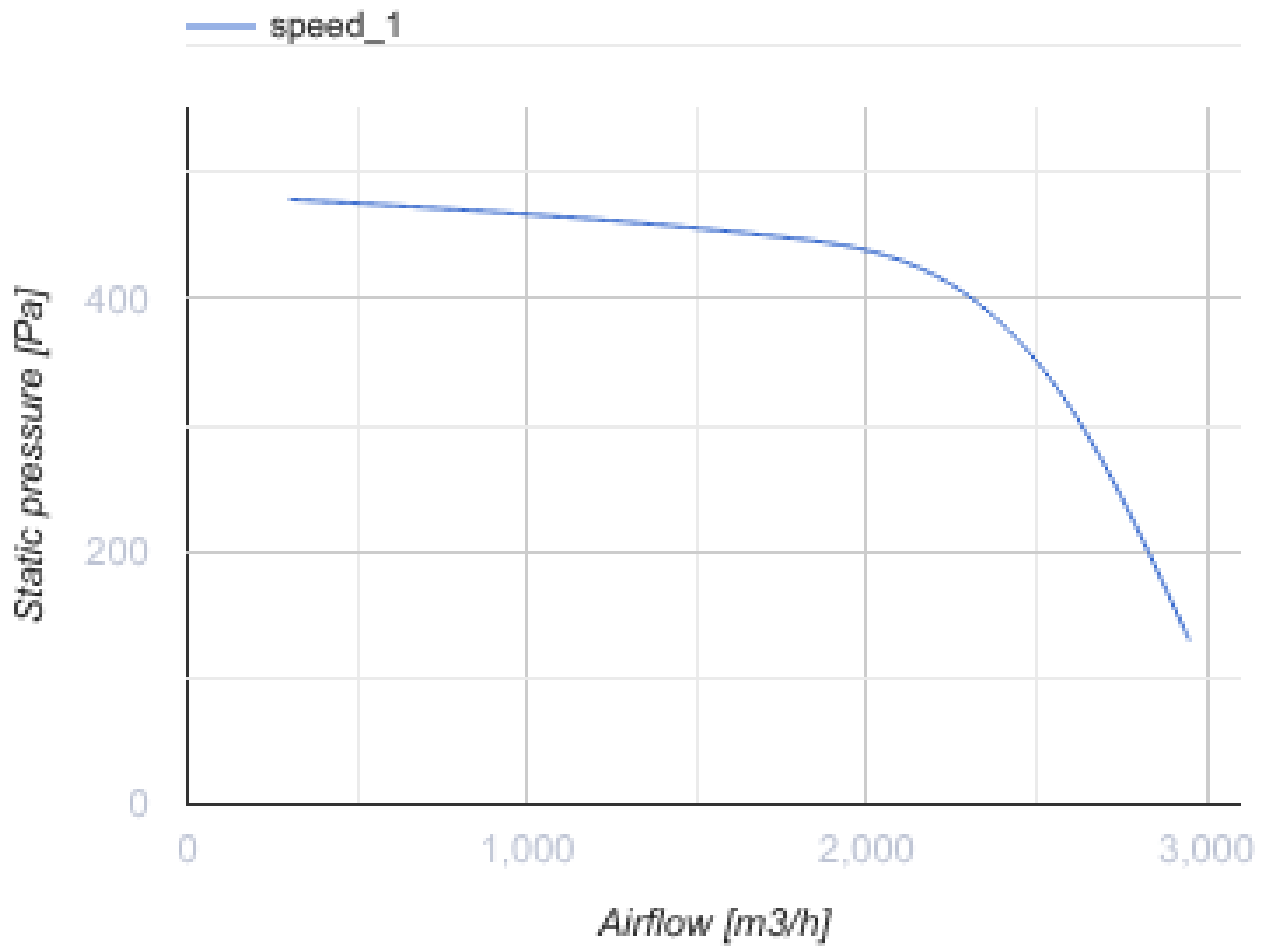

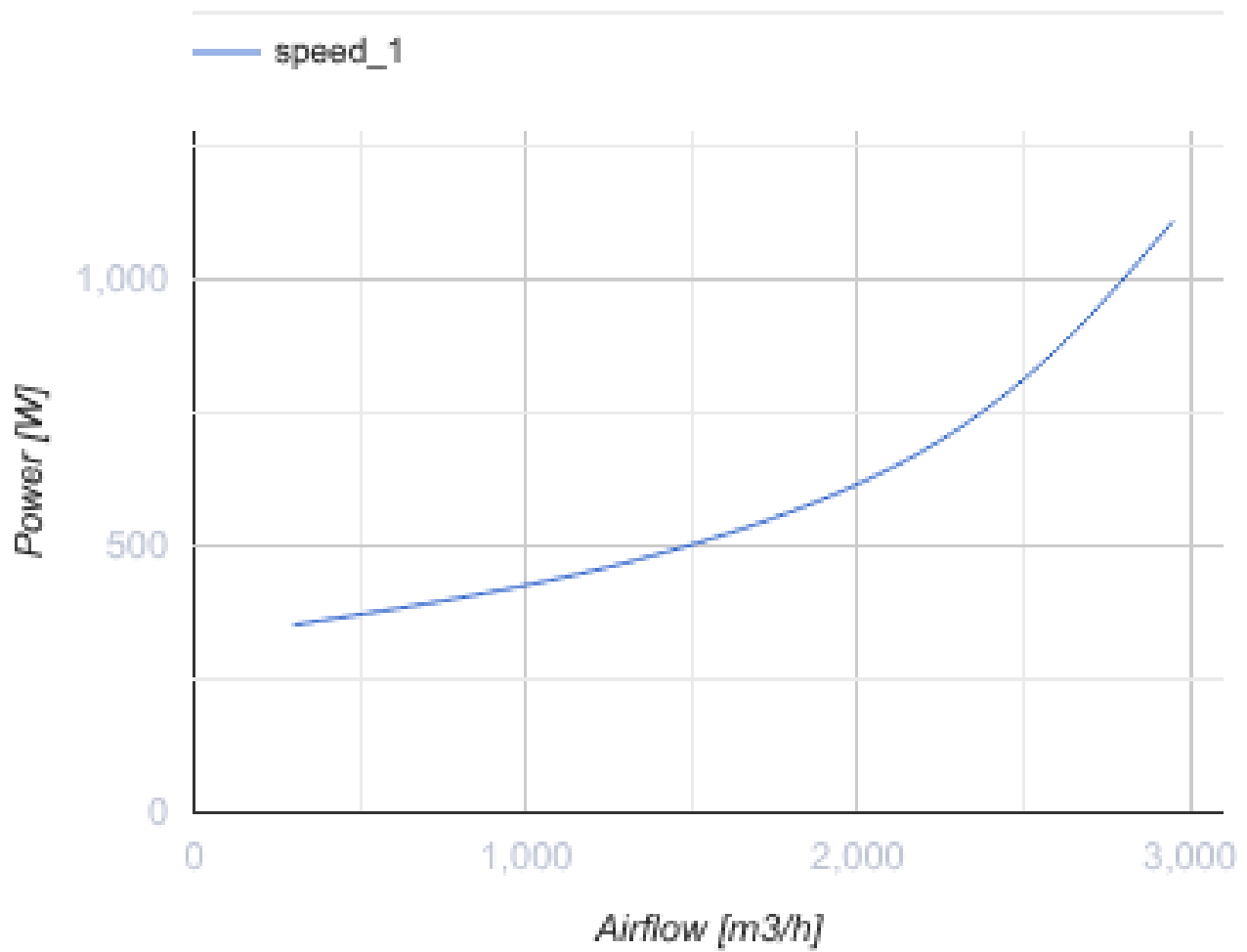

Dimensions

B	B1	B2	H	H1	H2	H3	L
600	620	640	300	320	340	375	680

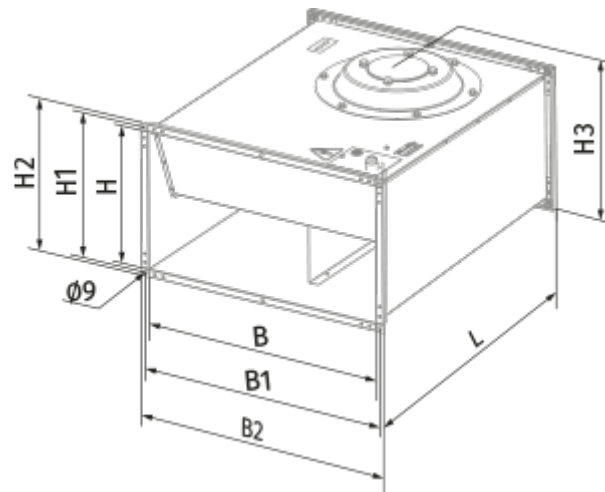







Ecodesign

Trademark	Blauberg
Model	Box-F 600x300 4E
Type of drive installed	External MSD or VSD
Type of heat recovery system	None
Nominal external pressure (Pa)	473
Maximum external leakage rates (%)	2.7
Static efficiency (%)	34.4
Declared typology	NRVU UVU
Effective electric power input (kW)	0.555
Sound power level (dB(A))	79

Accessories

Transformer speed controllers

Name	Photo	Description
CDR5E D1.5 M		Three phase speed controller
CDR5E D4.0 M		Three phase speed controller
CDR5E D6.0 M		Three phase speed controller
CDR5E D8.0 M		Three phase speed controller
CDR5E D11.0 M		Three phase speed controller
CDR5E D14.0 M		Three phase speed controller