



## Box EC 70x40-1

Centrifugal inline fans with backward curved blades with EC-motors

- Maximum airflow: 5710
- Sound pressure level LpA at 3 m: 53
- Motor type: EC
- Impeller type: Centrifugal backward curved blades
- Casing material: Galvanized steel
- Installation in any position

	Unit of measurement	Box EC 70x40-1
Connected air duct size	mm	700x400
Speed	-	1
Minimum supply voltage	V	230
Maximum supply voltage	V	230
Power supply frequency	Hz	50/60
Rated power	W	795
Unit current	A	3.48
Maximum airflow	m <sup>3</sup> /h	5710
Sound pressure level LpA at 3 m	dB(A)	53
Weight	kg	42.2
Transported air temperature (max)	°C	50
Transported air temperature (min)	°C	-25
Ingress protection rating	-	IPX4
Ingress protection rating of the drive	-	IP54

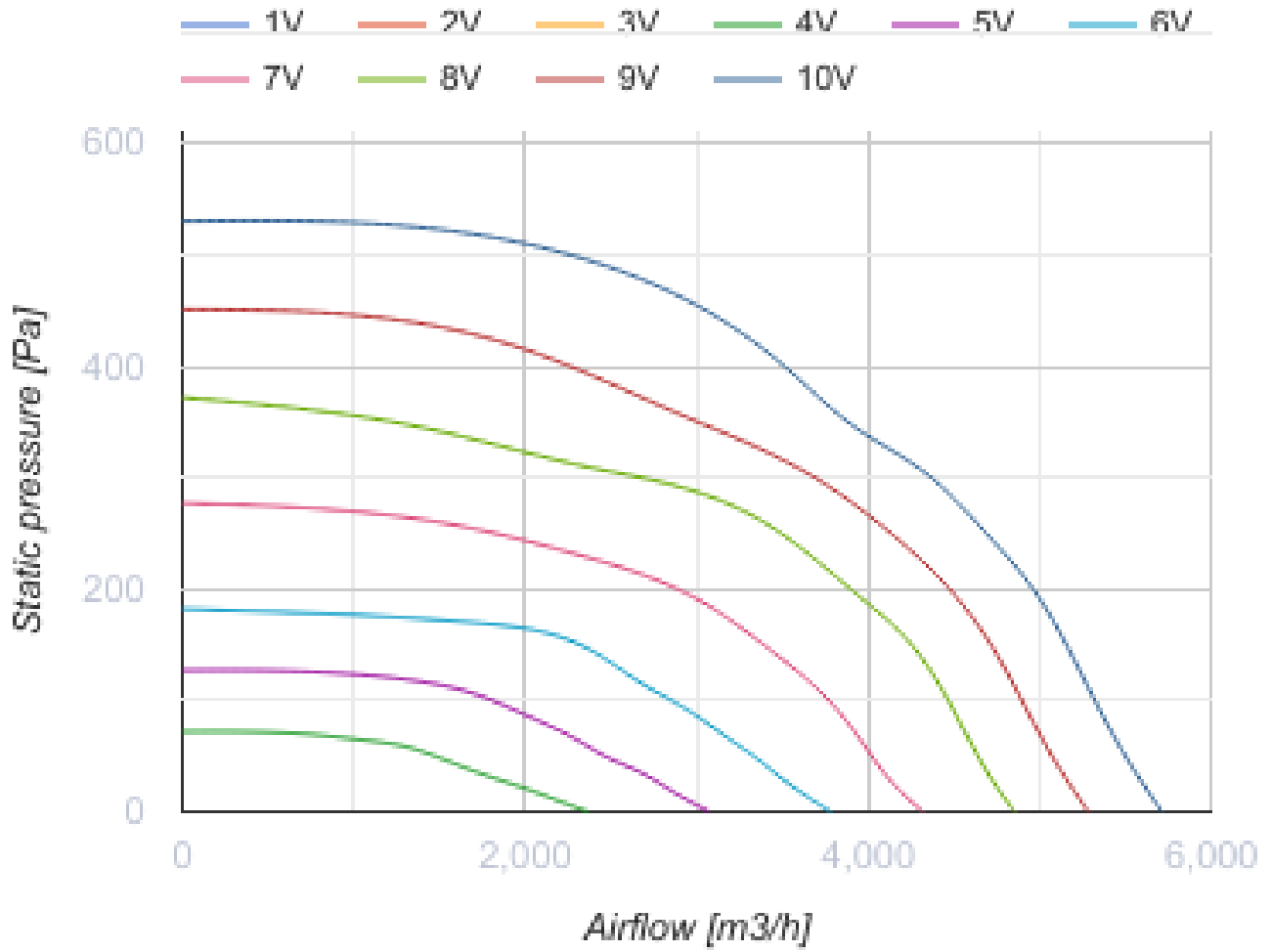

### Dimensions

H	H1	H2	H3	L	W	W1	W2
400	420	440	496	750	700	720	740

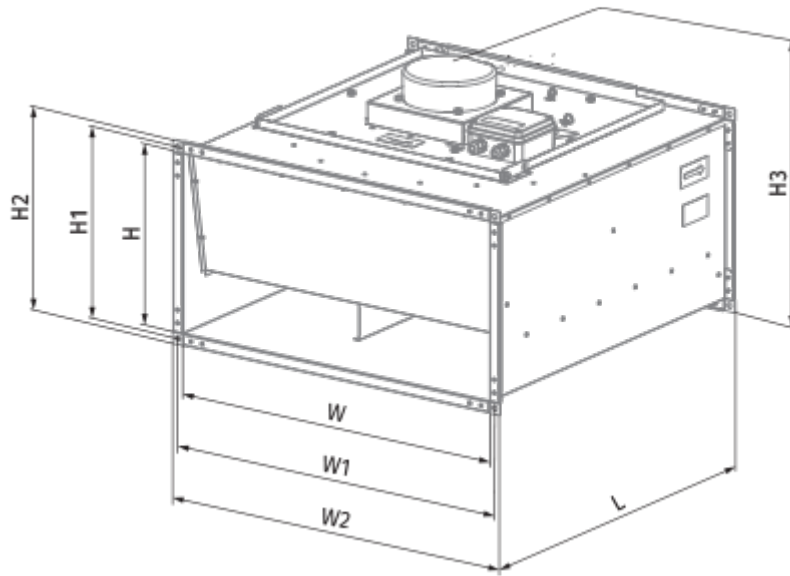

## Ecodesign

Trademark	Blauberg
Model	Box EC 70x40-1
Type of ventilation unit	Unidirectional
Type of drive installed	Integrated VSD
Type of heat recovery system	None
Nominal flow rate (m <sup>3</sup> /s)	0.662
Nominal external pressure (Pa)	145
Maximum external leakage rates (%)	2.7
Static efficiency (%)	57.5
Declared typology	NRVU UVU
Sound power level (dB(A))	73
Effective electric power input (kW)	0.194

## Accessories

### Other accessories

Name	Photo	Description
<a href="#">CDT E/0-10</a>		Speed control for EC motors