



BLAUBOX MW 3200-4 Pro

Supply ventilation units

- Maximum airflow: 3250
- Sound pressure level LpA at 3 m: 53
- Sound insulation
- Motor type: AC
- Reheater: Water
- Control: Remote Control
- Casing material: Galvanized steel

	Unit of measurement	BLAUBOX MW 3200-4 Pro
Connected air duct size	mm	600x350
Speed	-	1
Connection type	-	Y
Minimum supply voltage	V	400
Maximum supply voltage	V	400
Power supply frequency	Hz	50
Rated power	W	1270
Unit current	A	2.3
Maximum airflow	m ³ /h	3250
Sound pressure level LpA at 3 m	dB(A)	53
Weight	kg	73.1
Transported air temperature (max)	°C	45
Transported air temperature (min)	°C	-40
Ambient air temperature min	°C	1
Ambient air temperature max	°C	40
Ambient air humidity max	%	80
Ingress protection rating	-	IP22
Ingress protection rating of the drive	-	IP44

Dimensions

B	B2	B3	H	H1	L
710	1000	600	530	350	1000

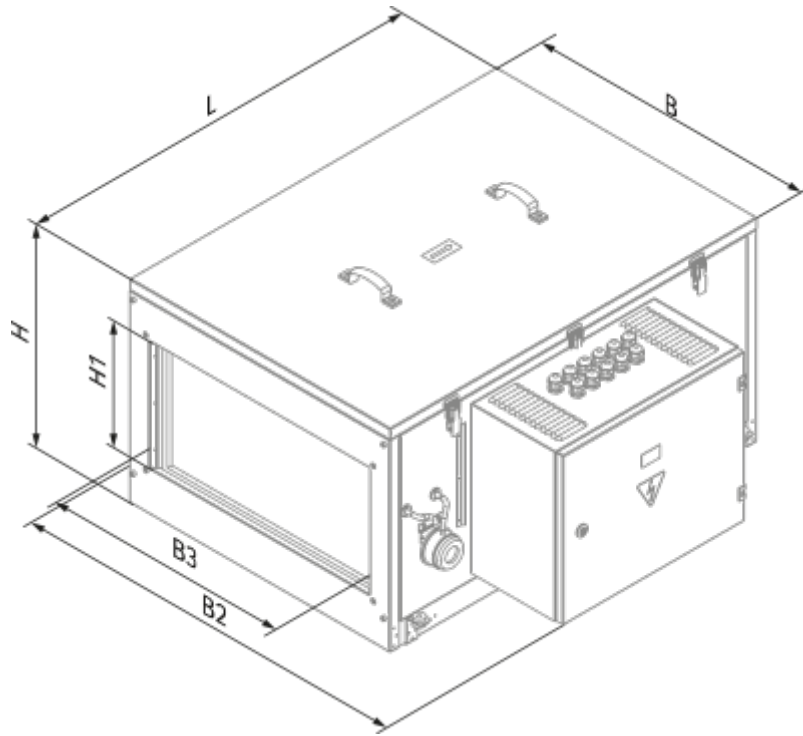

Accessories

Other accessories

Name	Photo	Description
FP 653x440x47 G4		G4 panel filter

For rectangular ducts

Name	Photo	Description
SD 60x35		Silencers for rectangular ducts

Freon coolers









Name	Photo	Description
------	-------	-------------

KFK 60x35-3		Duct DX cooling units for rectangular air ducts
-----------------------------	---	---

Water coolers

Name	Photo	Description
KWK 60x35-3		Duct water cooling units for rectangular air ducts

Mixing chambers

Name	Photo	Description
WMG 3/4-4		Water mixing units
WMG 3/4-6		Water mixing units
WMG 1-6		Water mixing units
WMG 1-10		Water mixing units
WMG 1 1/4-10		Water mixing units
WMG 1 1/4-16		Water mixing units
WMG 1 1/2-16		Water mixing units
WMG 1 1/2-25		Water mixing units
WMG 2-25		Water mixing units
WMG 2-40		Water mixing units