



# BLAUBOX MW 3000-4 Pro

Supply ventilation units

- Maximum airflow: 3000
- Sound pressure level LpA at 3 m: 53
- Sound insulation
- Motor type: AC
- Reheater: Water
- Control: Remote Control
- Casing material: Galvanized steel

	Unit of measurement	BLAUBOX MW 3000-4 Pro
Connected air duct size	mm	600x300
Speed	-	1
Connection type	-	Y
Minimum supply voltage	V	400
Maximum supply voltage	V	400
Power supply frequency	Hz	50
Rated power	W	1270
Unit current	A	2.3
Maximum airflow	m <sup>3</sup> /h	3000
Sound pressure level LpA at 3 m	dB(A)	53
Weight	kg	73.2
Transported air temperature (max)	°C	45
Transported air temperature (min)	°C	-40
Ambient air temperature min	°C	1
Ambient air temperature max	°C	40
Ambient air humidity max	%	80
Ingress protection rating	-	IP22
Ingress protection rating of the drive	-	IP44

## Dimensions

B	B2	B3	H	H1	L
710	1000	600	530	300	1000

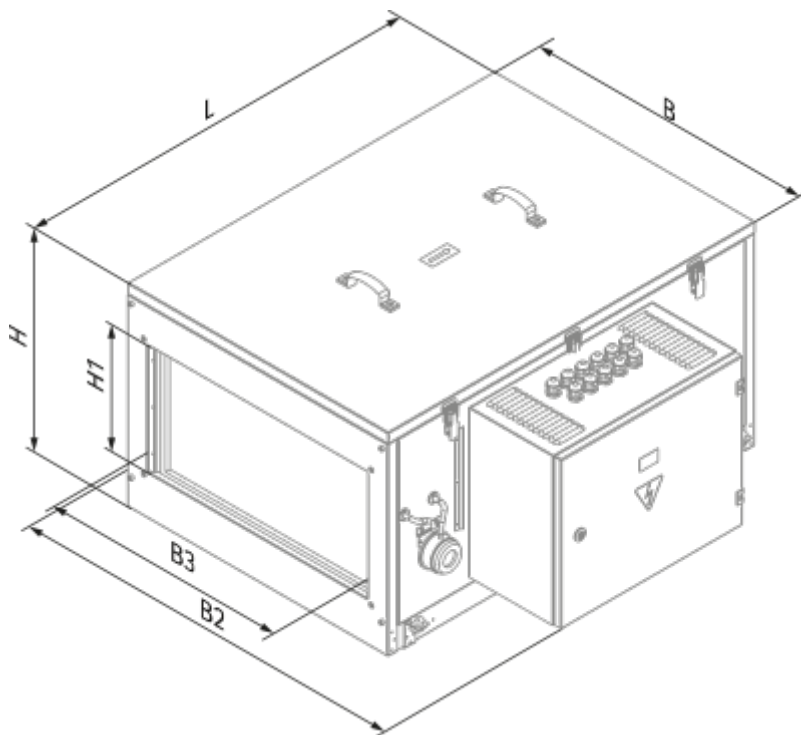

## Accessories

### Other accessories

Name	Photo	Description
FP 653x440x47 G4		G4 panel filter

### For rectangular ducts

Name	Photo	Description
<a href="#">SD 60x30</a>		Silencers for rectangular ducts

### Freon coolers









Name	Photo	Description
------	-------	-------------

<a href="#">KFK 60x30-3</a>		Duct DX cooling units for rectangular air ducts
-----------------------------	---	---

### Water coolers

Name	Photo	Description
<a href="#">KWK 60x30-3</a>		Duct water cooling units for rectangular air ducts

### Mixing chambers

Name	Photo	Description
<a href="#">WMG 3/4-4</a>		Water mixing units
<a href="#">WMG 3/4-6</a>		Water mixing units
<a href="#">WMG 1-6</a>		Water mixing units
<a href="#">WMG 1-10</a>		Water mixing units
<a href="#">WMG 1 1/4-10</a>		Water mixing units
<a href="#">WMG 1 1/4-16</a>		Water mixing units
<a href="#">WMG 1 1/2-16</a>		Water mixing units
<a href="#">WMG 1 1/2-25</a>		Water mixing units
<a href="#">WMG 2-25</a>		Water mixing units
<a href="#">WMG 2-40</a>		Water mixing units

### Airflow regulators

Name	Photo	Description
<a href="#">SL 60x30</a>		Air dampers for rectangular ducts

**For rectangular ducts**

Name	Photo	Description
<a href="#">EVA 60x30</a>		Flexible anti-vibration connectors for rectangular ducts