



BLAUBOX MW 2100-4 Pro

Supply ventilation units

- Maximum airflow: 2150
- Sound pressure level LpA at 3 m: 45
- Sound insulation
- Motor type: AC
- Reheater: Water
- Control: Remote Control
- Casing material: Galvanized steel

	Unit of measurement	BLAUBOX MW 2100-4 Pro
Connected air duct size	mm	500x300
Speed	-	1
Minimum supply voltage	V	230
Maximum supply voltage	V	230
Power supply frequency	Hz	50
Rated power	W	650
Unit current	A	2.84
Maximum airflow	m ³ /h	2150
Sound pressure level LpA at 3 m	dB(A)	45
Weight	kg	63
Transported air temperature (max)	°C	45
Transported air temperature (min)	°C	-40
Ambient air temperature min	°C	1
Ambient air temperature max	°C	40
Ambient air humidity max	%	80
Ingress protection rating	-	IP22
Ingress protection rating of the drive	-	IP44

Dimensions

B	B2	B3	H	H1	L
600	775	500	480	300	800

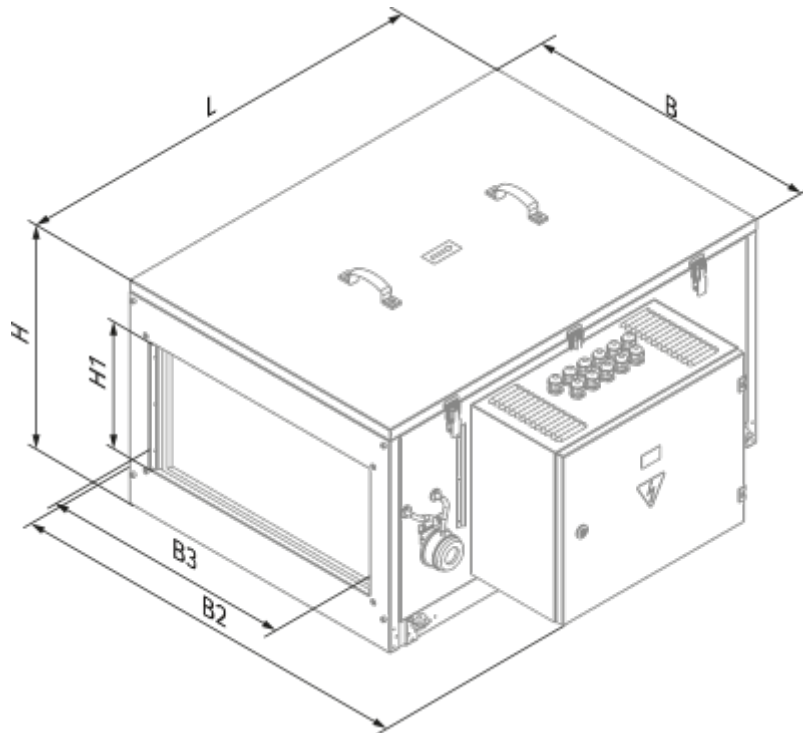

Accessories

Other accessories

Name	Photo	Description
FP 545x390x47 G4		G4 panel filter

For rectangular ducts

Name	Photo	Description
SD 50x30		Silencers for rectangular ducts

Freon coolers









Name	Photo	Description
------	-------	-------------

KFK 50x30-3		Duct DX cooling units for rectangular air ducts
-----------------------------	---	---

Water coolers

Name	Photo	Description
KWK 50x30-3		Duct water cooling units for rectangular air ducts

Mixing chambers

Name	Photo	Description
WMG 3/4-4		Water mixing units
WMG 3/4-6		Water mixing units
WMG 1-6		Water mixing units
WMG 1-10		Water mixing units
WMG 1 1/4-10		Water mixing units
WMG 1 1/4-16		Water mixing units
WMG 1 1/2-16		Water mixing units
WMG 1 1/2-25		Water mixing units
WMG 2-25		Water mixing units
WMG 2-40		Water mixing units