



BLAUBOX MW 1200-4 Pro

Supply ventilation units

- Maximum airflow: 1200
- Sound pressure level LpA at 3 m: 38
- Sound insulation
- Motor type: AC
- Reheater: Water
- Control: Remote Control
- Casing material: Galvanized steel

	Unit of measurement	BLAUBOX MW 1200-4 Pro
Connected air duct size	mm	400x200
Speed	-	1
Minimum supply voltage	V	230
Maximum supply voltage	V	230
Power supply frequency	Hz	50
Rated power	W	410
Unit current	A	1.8
Maximum airflow	m ³ /h	1200
Sound pressure level LpA at 3 m	dB(A)	38
Weight	kg	42.8
Transported air temperature (max)	°C	45
Transported air temperature (min)	°C	-40
Ambient air temperature min	°C	1
Ambient air temperature max	°C	40
Ambient air humidity max	%	80
Ingress protection rating	-	IP22
Ingress protection rating of the drive	-	IP44

Dimensions

B	B2	B3	H	H1	L
500	674	400	352	200	650

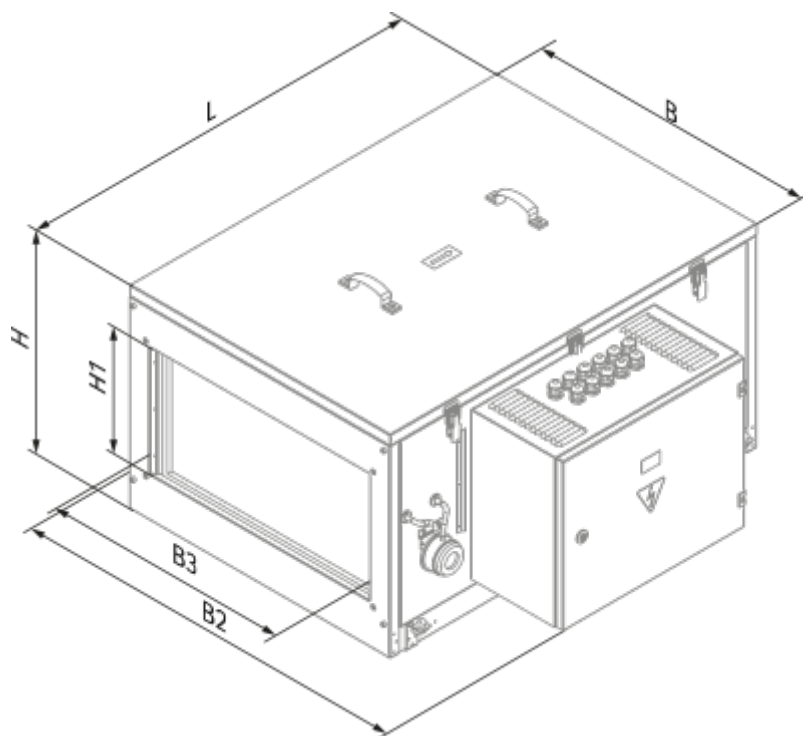

Accessories

Other accessories













Name	Photo	Description
FP 442x275x47 G4		G4 panel filter

Other accessories

Name	Photo	Description
SD 40x20		Silencers for rectangular ducts

Other accessories

Name	Photo	Description
------	-------	-------------

KFK 40x20-3		Duct DX cooling units for rectangular air ducts
KWK 40x20-3		Duct water cooling units for rectangular air ducts
WMG 3/4-4		Water mixing units
WMG 3/4-6		Water mixing units
WMG 1-6		Water mixing units
WMG 1-10		Water mixing units
WMG 1 1/4-10		Water mixing units
WMG 1 1/4-16		Water mixing units
WMG 1 1/2-16		Water mixing units
WMG 1 1/2-25		Water mixing units
WMG 2-25		Water mixing units
WMG 2-40		Water mixing units

Other accessories

Name	Photo	Description
SL 40x20		Air dampers for rectangular ducts

[EVA 40x20](#)



Flexible anti-vibration connectors for rectangular ducts