



BLAUBOX ME 800-3.3 Pro

Supply ventilation units

- Power of electrical reheater: 3300
- Maximum airflow: 800
- Sound pressure level LpA at 3 m: 35
- Sound insulation
- Motor type: AC
- Reheater: Electric
- Control: Remote Control
- Casing material: Galvanized steel

	Unit of measurement	BLAUBOX ME 800-3.3 Pro
Connected air duct size	mm	400x200
Speed	-	1
Minimum supply voltage	V	230
Maximum supply voltage	V	230
Power supply frequency	Hz	50
Rated power	W	245
Power of electrical reheater	W	3300
Unit current	A	15.4
Maximum airflow	m ³ /h	800
Sound pressure level LpA at 3 m	dB(A)	35
Weight	kg	36.2
Transported air temperature (max)	°C	45
Transported air temperature (min)	°C	-25
Ambient air temperature min	°C	1
Ambient air temperature max	°C	40
Ambient air humidity max	%	80
Ingress protection rating	-	IP22
Ingress protection rating of the drive	-	IP44

Dimensions

B	B1	B2	H	L	L1
500	400	549	352	650	530

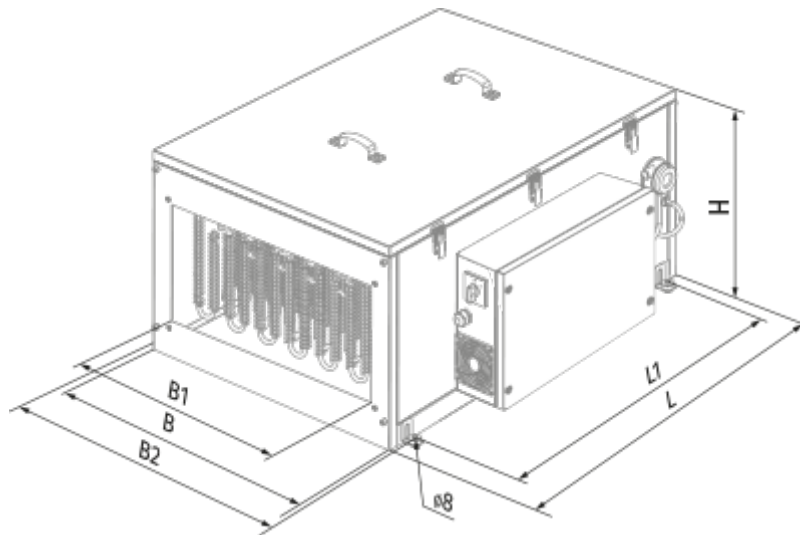

Accessories

Other accessories

Name	Photo	Description
FP 442x275x47 G4		G4 panel filter

For rectangular ducts

Name	Photo	Description
SD 40x20		Silencers for rectangular ducts

Freon coolers

Name	Photo	Description
KFK 40x20-3		Duct DX cooling units for rectangular air ducts

Airflow regulators

Name	Photo	Description
SL 40x20		Air dampers for rectangular ducts

For rectangular ducts

Name	Photo	Description
EVA 40x20		Flexible anti-vibration connectors for rectangular ducts