

Blaubox EC ME 4000-24 S31

Supply ventilation units with an electric heater

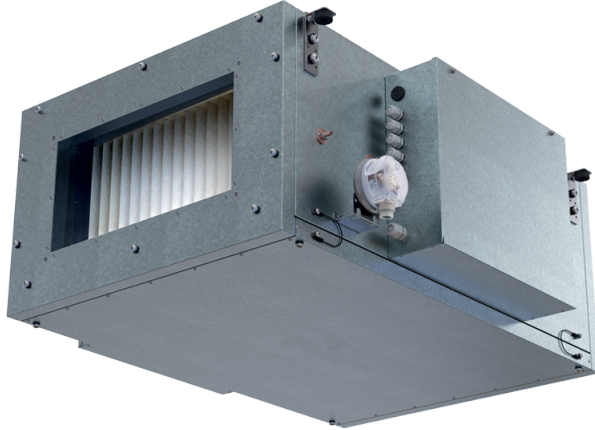

- Power of electrical reheater: 24000
- Maximum airflow: 5000
- Sound pressure level LpA at 3 m: 49
- Filter: Coarse 90% / G4 (option: ePM1 70% / F7)
- Sound insulation
- Motor type: EC
- Reheater: Electric
- BMS protocol: ModBus
- Control: Wired control panel
- Casing material: Aluzinc steel

	Unit of measurement	Blaubox EC ME 4000-24 S31
Connected air duct size	mm	700x400
Phases	-	3
Minimum supply voltage	V	400
Maximum supply voltage	V	400
Power supply frequency	Hz	50
Rated power	W	717
Power of electrical reheater	W	24000
Unit current	A	42.9
Maximum airflow	m ³ /h	5000
Sound pressure level LpA at 3 m	dB(A)	49
Weight	kg	60
Filter	-	Coarse 90% / G4 (option: ePM1 70% / F7)
Transported air temperature (max)	°C	40
Transported air temperature (min)	°C	-30
Ambient air temperature min	°C	1
Ambient air temperature max	°C	40
Ambient air humidity max	%	80
Ingress protection rating	-	IP22
Ingress protection rating of the drive	-	IP44

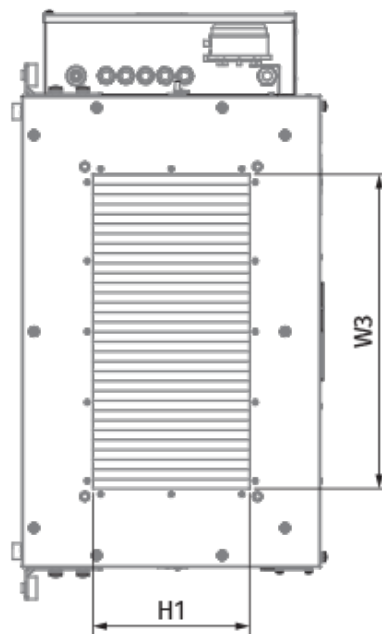
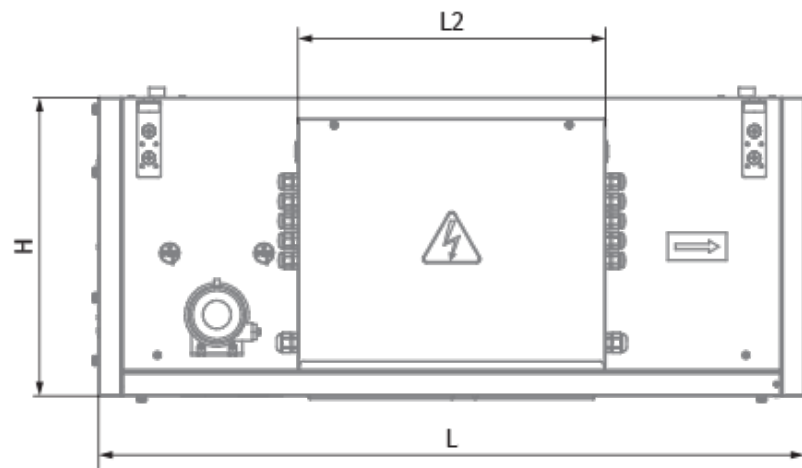

Dimensions

H	H1	L	L1	W	W1	W2	W3
550	400	1200	1070	940	993	1087	700





Accessories

Other accessories

Name	Photo	Description
FP 874x485x80 Coarse 90% / G4		G4 panel filter
FP 874x485x80 ePM1 70% / F7		F7 panel filter



Other accessories

Name	Photo	Description
EVA 70x40		Flexible anti-vibration connectors for rectangular ducts
SL 70x40		Air dampers for rectangular ducts

Other accessories

Name	Photo	Description
SD 70x40		Silencers for rectangular ducts

Other accessories

Name	Photo	Description
Belimo TF24		Electric actuators
Belimo TF230		Electric actuators