

Blaubox EC ME 3000-18 S31

Supply ventilation units with an electric heater

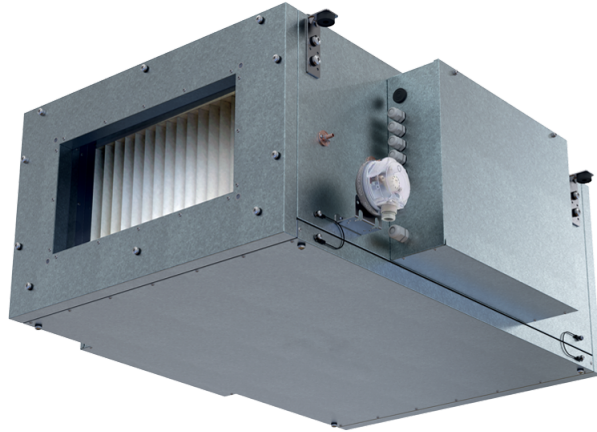

- Power of electrical reheater: 18000
- Maximum airflow: 3150
- Sound pressure level LpA at 3 m: 47
- Filter: Coarse 90% / G4 (option: ePM1 70% / F7)
- Sound insulation
- Motor type: EC
- Reheater: Electric
- BMS protocol: ModBus
- Control: Wired control panel
- Casing material: Aluzinc steel

| | Unit of measurement | Blaubox EC ME 3000-18 S31 |
|--|---------------------|---|
| Connected air duct size | mm | 600x300 |
| Phases | - | 3 |
| Minimum supply voltage | V | 400 |
| Maximum supply voltage | V | 400 |
| Power supply frequency | Hz | 50 |
| Rated power | W | 472 |
| Power of electrical reheater | W | 18000 |
| Unit current | A | 29.6 |
| Maximum airflow | m ³ /h | 3150 |
| Sound pressure level LpA at 3 m | dB(A) | 47 |
| Weight | kg | 50 |
| Filter | - | Coarse 90% / G4 (option: ePM1 70% / F7) |
| Transported air temperature (max) | °C | 40 |
| Transported air temperature (min) | °C | -30 |
| Ambient air temperature min | °C | 1 |
| Ambient air temperature max | °C | 40 |
| Ambient air humidity max | % | 80 |
| Ingress protection rating | - | IP22 |
| Ingress protection rating of the drive | - | IP44 |

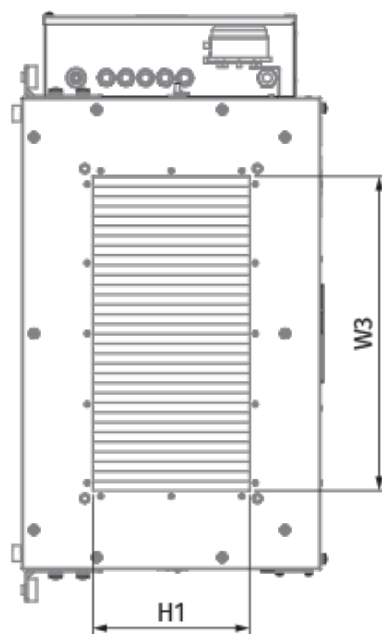
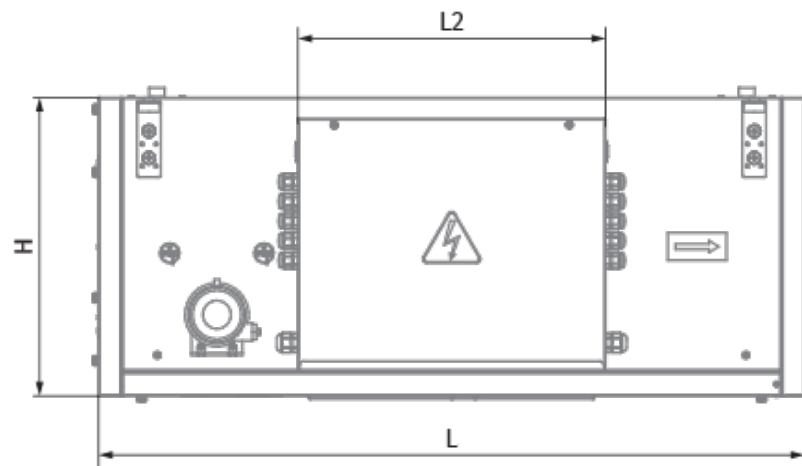

Dimensions

| H | H1 | L | L1 | W | W1 | W2 | W3 |
|-----|-----|------|------|-----|-----|-----|-----|
| 500 | 300 | 1200 | 1070 | 800 | 853 | 944 | 600 |



Accessories

Other accessories

| Name | Photo | Description |
|-------------------------------|---|-----------------|
| FP 734x435x80 Coarse 90% / G4 |  | G4 panel filter |
| FP 734x435x80 ePM1 70% / F7 |  | F7 panel filter |

For rectangular ducts

| Name | Photo | Description |
|---------------------------|---|--|
| EVA 60x30 |  | Flexible anti-vibration connectors for rectangular ducts |

For rectangular ducts

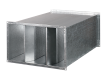
| Name | Photo | Description |
|--------------------------|---|---------------------------------|
| SD 60x30 |  | Silencers for rectangular ducts |

Airflow regulators

| Name | Photo | Description |
|--------------------------|---|-----------------------------------|
| SL 60x30 |  | Air dampers for rectangular ducts |

Electric actuators

| Name | Photo | Description |
|-----------------------------|---|--------------------|
| Belimo TF24 |  | Electric actuators |

[Belimo TF230](#)



Electric actuators