

Blaubox EC ME 2000-24 S31

Supply ventilation units with an electric heater

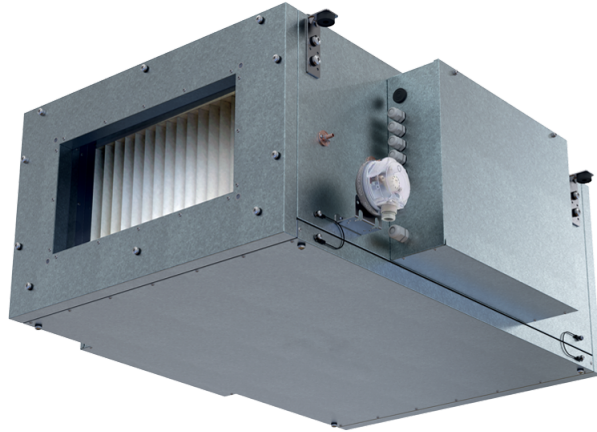

- Power of electrical reheater: 24000
- Maximum airflow: 2450
- Sound pressure level LpA at 3 m: 48
- Filter: Coarse 90% / G4 (option: ePM1 70% / F7)
- Sound insulation
- Motor type: EC
- Reheater: Electric
- BMS protocol: ModBus
- Control: Wired control panel
- Casing material: Aluzinc steel

	Unit of measurement	Blaubox EC ME 2000-24 S31
Connected air duct size	mm	500x300
Phases	-	3
Minimum supply voltage	V	400
Maximum supply voltage	V	400
Power supply frequency	Hz	50
Rated power	W	406
Power of electrical reheater	W	24000
Unit current	A	39.1
Maximum airflow	m ³ /h	2450
Sound pressure level LpA at 3 m	dB(A)	48
Weight	kg	40
Filter	-	Coarse 90% / G4 (option: ePM1 70% / F7)
Transported air temperature (max)	°C	40
Transported air temperature (min)	°C	-30
Ambient air temperature min	°C	1
Ambient air temperature max	°C	40
Ambient air humidity max	%	80
Ingress protection rating	-	IP22
Ingress protection rating of the drive	-	IP44

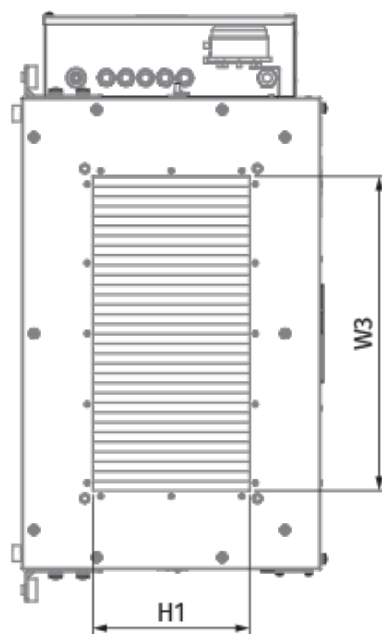
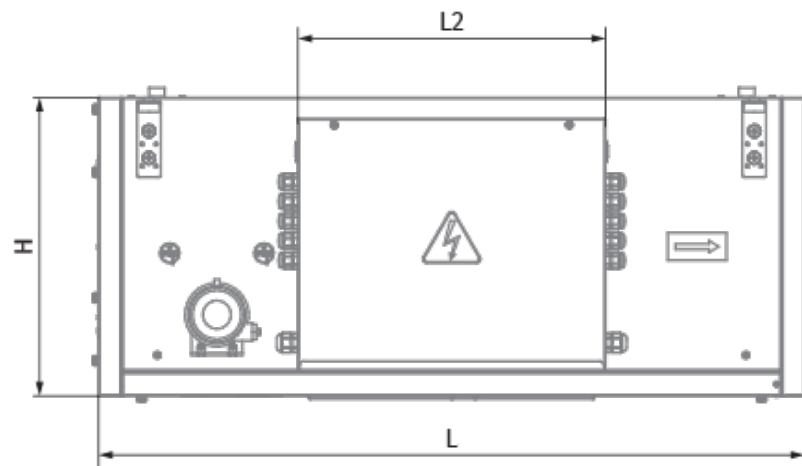

Dimensions

H	H1	L	L1	W	W1	W2	W3
440	300	900	770	700	754	847	500



Accessories

Other accessories

Name	Photo	Description
FP 636x376x48 Coarse 90% / G4		G4 panel filter
FP 636x376x48 ePM1 70% / F7		F7 panel filter

For rectangular ducts

Name	Photo	Description
EVA 50x30		Flexible anti-vibration connectors for rectangular ducts

For rectangular ducts

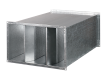
Name	Photo	Description
SD 50x30		Silencers for rectangular ducts

Airflow regulators

Name	Photo	Description
SL 50x30		Air dampers for rectangular ducts

Electric actuators

Name	Photo	Description
Belimo TF24		Electric actuators

[Belimo TF230](#)



Electric actuators