



# BLAUBOX E 800-5.1 Pro

Supply ventilation units

- Power of electrical reheater: 5100
- Maximum airflow: 810
- Sound pressure level LpA at 3 m: 30
- Sound insulation
- Motor type: AC
- Reheater: Electric
- Control: Remote Control
- Casing material: Galvanized steel

	Unit of measurement	BLAUBOX E 800-5.1 Pro
Connected air duct size	mm	200
Speed	-	1
Minimum supply voltage	V	400
Maximum supply voltage	V	400
Power supply frequency	Hz	50
Rated power	W	193
Power of electrical reheater	W	5100
Unit current	A	7.4
Maximum airflow	m <sup>3</sup> /h	810
Sound pressure level LpA at 3 m	dB(A)	30
Weight	kg	52
Transported air temperature (max)	°C	55
Transported air temperature (min)	°C	-25
Ambient air temperature min	°C	0
Ambient air temperature max	°C	40
Ambient air humidity max	%	80
Ingress protection rating	-	IP22
Ingress protection rating of the drive	-	IP44

## Dimensions

$\varnothing D$	B	B1	H	L	L1
199	487	526.5	513	835	684

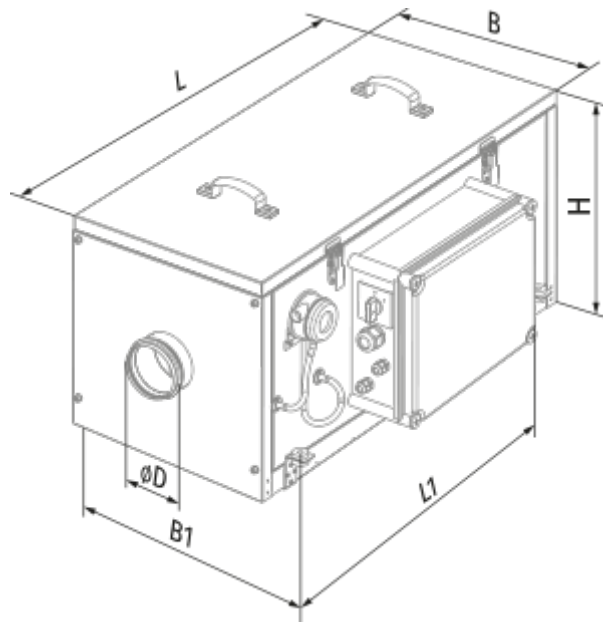







## Accessories

### Other accessories

Name	Photo	Description
FP 439x428x70 G4		G4 panel filter

### For round ducts

Name	Photo	Description
<a href="#">SD 200/600</a>		Silencers for round ducts
<a href="#">SD 200/900</a>		Silencers for round ducts
<a href="#">SD 200/1200</a>		Silencers for round ducts

<a href="#">SDF 200/600</a>		Flexible silencers for round ducts
<a href="#">SDF 200/900</a>		Flexible silencers for round ducts
<a href="#">SDF 200/2000</a>		Flexible silencers for round ducts

### For round ducts

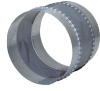
Name	Photo	Description
<a href="#">EVA 200</a>		Flexible anti-vibration connectors for round ducts

### For round ducts

Name	Photo	Description
<a href="#">VRV 200</a>		Backdraft dampers with spring for round ducts
<a href="#">VKA 200</a>		Air dampers for round ducts