



BLAUBOX E 400-3.4 Pro

Supply ventilation units

- Power of electrical reheater: 3400
- Maximum airflow: 425
- Sound pressure level LpA at 3 m: 29
- Sound insulation
- Motor type: AC
- Reheater: Electric
- Control: Remote Control
- Casing material: Galvanized steel

	Unit of measurement	BLAUBOX E 400-3.4 Pro
Connected air duct size	mm	150
Speed	-	1
Minimum supply voltage	V	230
Maximum supply voltage	V	230
Power supply frequency	Hz	50
Rated power	W	98
Power of electrical reheater	W	3400
Unit current	A	14.8
Maximum airflow	m ³ /h	425
Sound pressure level LpA at 3 m	dB(A)	29
Weight	kg	52
Transported air temperature (max)	°C	55
Transported air temperature (min)	°C	-25
Ambient air temperature min	°C	0
Ambient air temperature max	°C	40
Ambient air humidity max	%	80
Ingress protection rating	-	IP22
Ingress protection rating of the drive	-	IP44

Dimensions

ØD	B	B1	H	L	L1
149	455	496.5	438	800	647

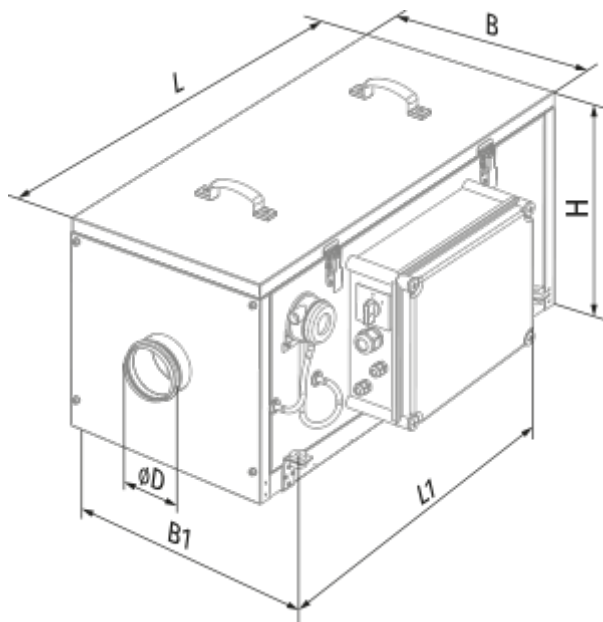





Accessories

Other accessories



Name	Photo	Description
FP 397x364x70 G4		G4 panel filter

Other accessories

Name	Photo	Description
SD 150/600		Silencers for round ducts
SD 150/900		Silencers for round ducts
SD 150/1200		Silencers for round ducts

SDF 150/600		Flexible silencers for round ducts
SDF 150/900		Flexible silencers for round ducts
SDF 150/2000		Flexible silencers for round ducts

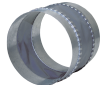
Other accessories

Name	Photo	Description
EVA 150		Flexible anti-vibration connectors for round ducts
VRV 150		Backdraft dampers with spring for round ducts
VKA 150		Air dampers for round ducts