



BLAUBOX E 200-1.8 Pro

Supply ventilation units

- Power of electrical reheater: 1800
- Maximum airflow: 190
- Sound pressure level LpA at 3 m: 27
- Sound insulation
- Motor type: AC
- Reheater: Electric
- Control: Remote Control
- Casing material: Galvanized steel

	Unit of measurement	BLAUBOX E 200-1.8 Pro
Connected air duct size	mm	100
Speed	-	1
Minimum supply voltage	V	230
Maximum supply voltage	V	230
Power supply frequency	Hz	50
Rated power	W	73
Power of electrical reheater	W	1800
Unit current	A	7.8
Maximum airflow	m ³ /h	190
Sound pressure level LpA at 3 m	dB(A)	27
Weight	kg	50
Transported air temperature (max)	°C	55
Transported air temperature (min)	°C	-25
Ambient air temperature min	°C	0
Ambient air temperature max	°C	40
Ambient air humidity max	%	80
Ingress protection rating	-	IP22
Ingress protection rating of the drive	-	IP44

Dimensions

ØD	B	B1	H	L	L1
99	382	421.5	408	800	647

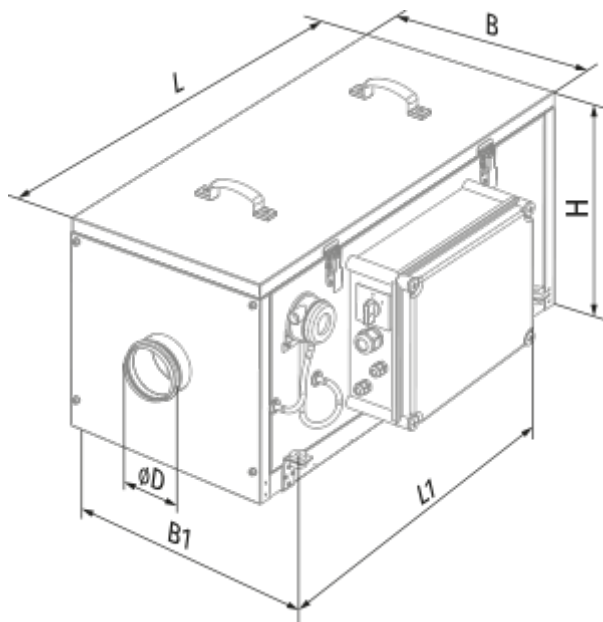





Accessories

Other accessories

Name	Photo	Description
FP 335x322x70 G4		G4 panel filter

For round ducts



Name	Photo	Description
SD 100/600		Silencers for round ducts
SD 100/900		Silencers for round ducts
SD 100/1200		Silencers for round ducts

SDF 100/600		Flexible silencers for round ducts
SDF 100/900		Flexible silencers for round ducts
SDF 100/2000		Flexible silencers for round ducts

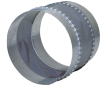
For round ducts

Name	Photo	Description
EVA 100		Flexible anti-vibration connectors for round ducts

For round ducts

Name	Photo	Description
VRV 100		Backdraft dampers with spring for round ducts
VKA 100		Air dampers for round ducts