



BLAUBOX E 1500-9 Pro

Supply ventilation units

- Power of electrical reheater: 9000
- Maximum airflow: 1250
- Sound pressure level LpA at 3 m: 30
- Sound insulation
- Motor type: AC
- Reheater: Electric
- Control: Remote Control
- Casing material: Galvanized steel

	Unit of measurement	BLAUBOX E 1500-9 Pro
Connected air duct size	mm	315
Speed	-	1
Minimum supply voltage	V	400
Maximum supply voltage	V	400
Power supply frequency	Hz	50
Rated power	W	296
Power of electrical reheater	W	9000
Unit current	A	13
Maximum airflow	m ³ /h	1250
Sound pressure level LpA at 3 m	dB(A)	30
Weight	kg	60
Transported air temperature (max)	°C	55
Transported air temperature (min)	°C	-25
Ambient air temperature min	°C	0
Ambient air temperature max	°C	40
Ambient air humidity max	%	80
Ingress protection rating	-	IP22
Ingress protection rating of the drive	-	IP44

Dimensions

ØD	B	B1	H	L	L1
314	527	566.5	548	900	750

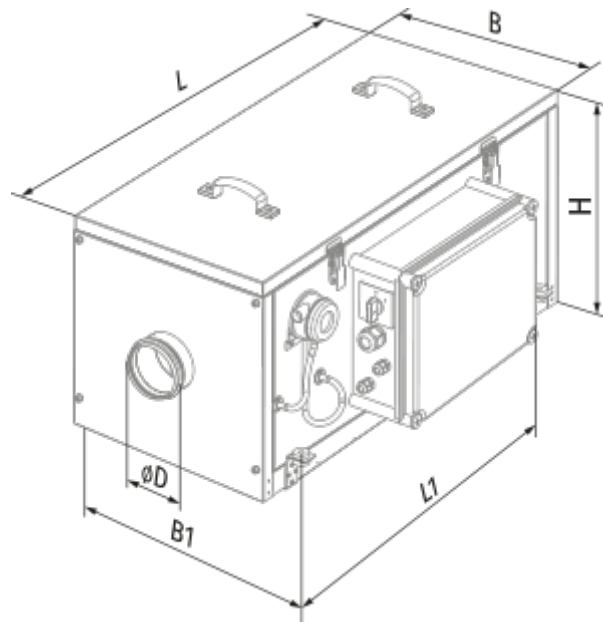







Accessories

Other accessories



Name	Photo	Description
FP 475x470x70 G4		G4 panel filter

Other accessories

Name	Photo	Description
SD 315/600		Silencers for round ducts
SD 315/900		Silencers for round ducts
SD 315/1200		Silencers for round ducts

SDF 315/600		Flexible silencers for round ducts
SDF 315/900		Flexible silencers for round ducts
SDF 315/2000		Flexible silencers for round ducts

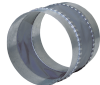
Other accessories

Name	Photo	Description
EVA 315		Flexible anti-vibration connectors for round ducts
VRV 315		Backdraft dampers with spring for round ducts
VKA 315		Air dampers for round ducts