



BLAUBOX E 1200-6 Pro

Supply ventilation units

- Power of electrical reheater: 6000
- Maximum airflow: 1190
- Sound pressure level LpA at 3 m: 30
- Sound insulation
- Motor type: AC
- Reheater: Electric
- Control: Remote Control
- Casing material: Galvanized steel

	Unit of measurement	BLAUBOX E 1200-6 Pro
Connected air duct size	mm	315
Speed	-	1
Minimum supply voltage	V	400
Maximum supply voltage	V	400
Power supply frequency	Hz	50
Rated power	W	171
Power of electrical reheater	W	6000
Unit current	A	8.7
Maximum airflow	m ³ /h	1190
Sound pressure level LpA at 3 m	dB(A)	30
Weight	kg	60
Transported air temperature (max)	°C	55
Transported air temperature (min)	°C	-25
Ambient air temperature min	°C	0
Ambient air temperature max	°C	40
Ambient air humidity max	%	80
Ingress protection rating	-	IP22
Ingress protection rating of the drive	-	IP44

Dimensions

$\varnothing D$	B	B1	H	L	L1
314	527	566.5	548	900	750

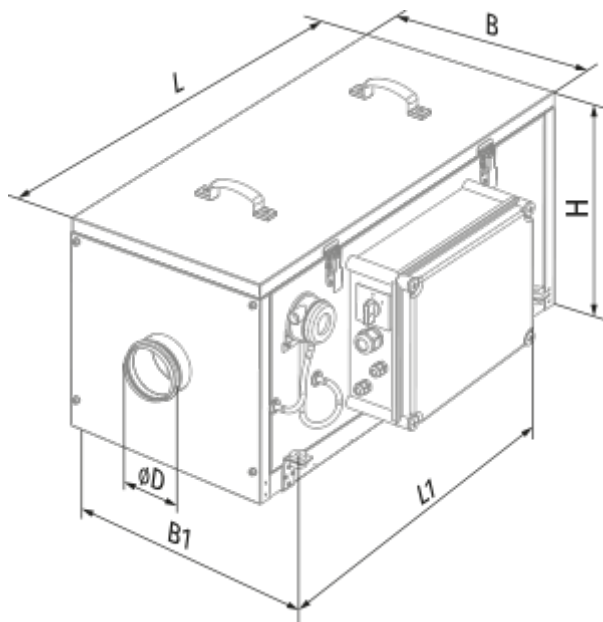







Accessories

Other accessories

Name	Photo	Description
FP 475x470x70 G4		G4 panel filter

For round ducts

Name	Photo	Description
SD 315/600		Silencers for round ducts
SD 315/900		Silencers for round ducts
SD 315/1200		Silencers for round ducts

SDF 315/600		Flexible silencers for round ducts
SDF 315/900		Flexible silencers for round ducts
SDF 315/2000		Flexible silencers for round ducts

For round ducts

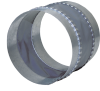
Name	Photo	Description
EVA 315		Flexible anti-vibration connectors for round ducts

For round ducts

Name	Photo	Description
VRV 315		Backdraft dampers with spring for round ducts
VKA 315		Air dampers for round ducts