



# BLAUBOX E 1000-9 Pro

Supply ventilation units

- Power of electrical reheater: 9000
- Maximum airflow: 990
- Sound pressure level LpA at 3 m: 30
- Sound insulation
- Motor type: AC
- Reheater: Electric
- Control: Remote Control
- Casing material: Galvanized steel

	Unit of measurement	BLAUBOX E 1000-9 Pro
Connected air duct size	mm	250
Speed	-	1
Minimum supply voltage	V	400
Maximum supply voltage	V	400
Power supply frequency	Hz	50
Rated power	W	194
Power of electrical reheater	W	9000
Unit current	A	13
Maximum airflow	m <sup>3</sup> /h	990
Sound pressure level LpA at 3 m	dB(A)	30
Weight	kg	55
Transported air temperature (max)	°C	55
Transported air temperature (min)	°C	-25
Ambient air temperature min	°C	0
Ambient air temperature max	°C	40
Ambient air humidity max	%	80
Ingress protection rating	-	IP22
Ingress protection rating of the drive	-	IP44

## Dimensions

ØD	B	B1	H	L	L1
249	487	526.5	513	835	684

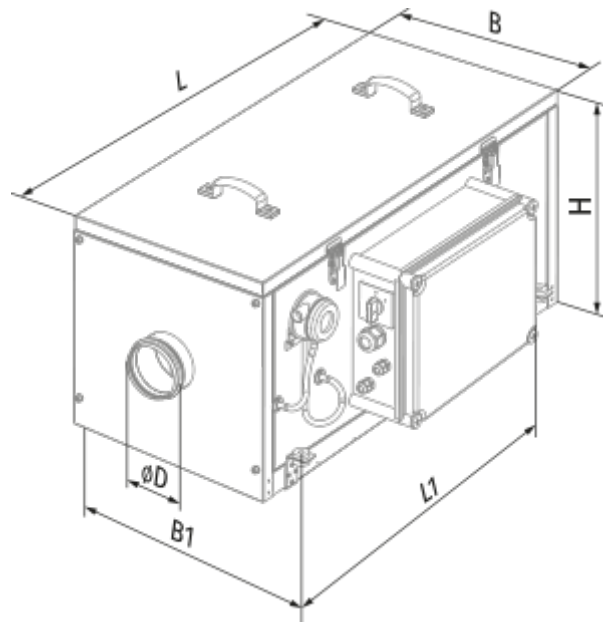





## Accessories

### Other accessories



Name	Photo	Description
FP 439x428x70 G4		G4 panel filter

### Other accessories

Name	Photo	Description
<a href="#">SD 250/600</a>		Silencers for round ducts
<a href="#">SD 250/900</a>		Silencers for round ducts
<a href="#">SD 250/1200</a>		Silencers for round ducts

<a href="#">SDF 250/600</a>		Flexible silencers for round ducts
<a href="#">SDF 250/900</a>		Flexible silencers for round ducts
<a href="#">SDF 250/2000</a>		Flexible silencers for round ducts

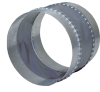
### Other accessories

Name	Photo	Description
<a href="#">EVA 250</a>		Flexible anti-vibration connectors for round ducts
<a href="#">VRV 250</a>		Backdraft dampers with spring for round ducts
<a href="#">VKA 250</a>		Air dampers for round ducts