



BLAUBOX E 1000-6 Pro

Supply ventilation units

- Power of electrical reheater: 6000
- Maximum airflow: 990
- Sound pressure level LpA at 3 m: 30
- Sound insulation
- Motor type: AC
- Reheater: Electric
- Control: Remote Control
- Casing material: Galvanized steel

	Unit of measurement	BLAUBOX E 1000-6 Pro
Connected air duct size	mm	250
Speed	-	1
Minimum supply voltage	V	400
Maximum supply voltage	V	400
Power supply frequency	Hz	50
Rated power	W	194
Power of electrical reheater	W	6000
Unit current	A	8.7
Maximum airflow	m ³ /h	990
Sound pressure level LpA at 3 m	dB(A)	30
Weight	kg	55
Transported air temperature (max)	°C	55
Transported air temperature (min)	°C	-25
Ambient air temperature min	°C	0
Ambient air temperature max	°C	40
Ambient air humidity max	%	80
Ingress protection rating	-	IP22
Ingress protection rating of the drive	-	IP44

Dimensions

ØD	B	B1	H	L	L1
249	487	526.5	513	835	684

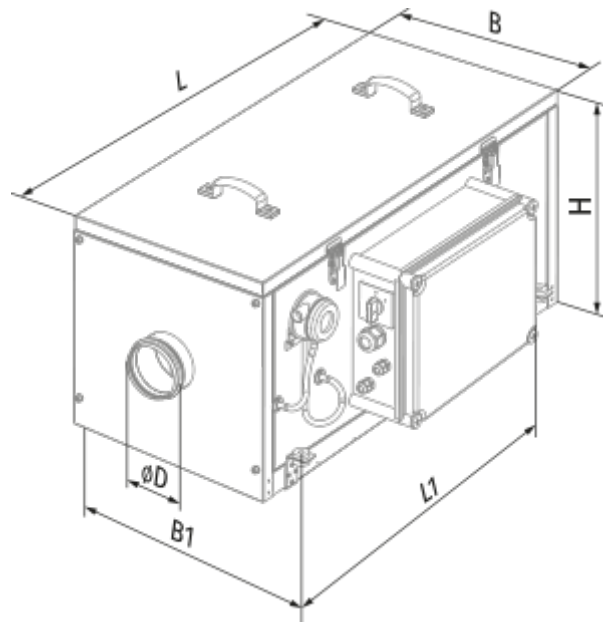





Accessories

Other accessories



Name	Photo	Description
FP 439x428x70 G4		G4 panel filter

Other accessories

Name	Photo	Description
SD 250/600		Silencers for round ducts
SD 250/900		Silencers for round ducts
SD 250/1200		Silencers for round ducts

SDF 250/600		Flexible silencers for round ducts
SDF 250/900		Flexible silencers for round ducts
SDF 250/2000		Flexible silencers for round ducts

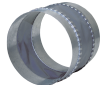
Other accessories

Name	Photo	Description
EVA 250		Flexible anti-vibration connectors for round ducts
VRV 250		Backdraft dampers with spring for round ducts
VKA 250		Air dampers for round ducts