



Axis-QRA 200

Axial wall fans

- Maximum airflow: 390
- Sound pressure level LpA at 3 m: 33
- Motor type: AC
- Impeller type: Axial
- Casing material: Coated steel
- Installation in any position

	Unit of measurement	Axis-QRA 200	
Connected air duct size	mm	200	
Speed	-	1	
Phases	-	1	
Minimum supply voltage	V	220	
Maximum supply voltage	V	240	
Power supply frequency	Hz	50	60
Rated power	W	33	
Unit current	A	0.23	
Maximum airflow	m ³ /h	390	
rotation speed at 50hz	-	1410	
Sound pressure level LpA at 3 m	dB(A)	33	
Weight	kg	2.5	
Transported air temperature (max)	°C	40	
Transported air temperature (min)	°C	-30	
Ingress protection rating	-	IPX4	
Ingress protection rating of the drive	-	IP44	

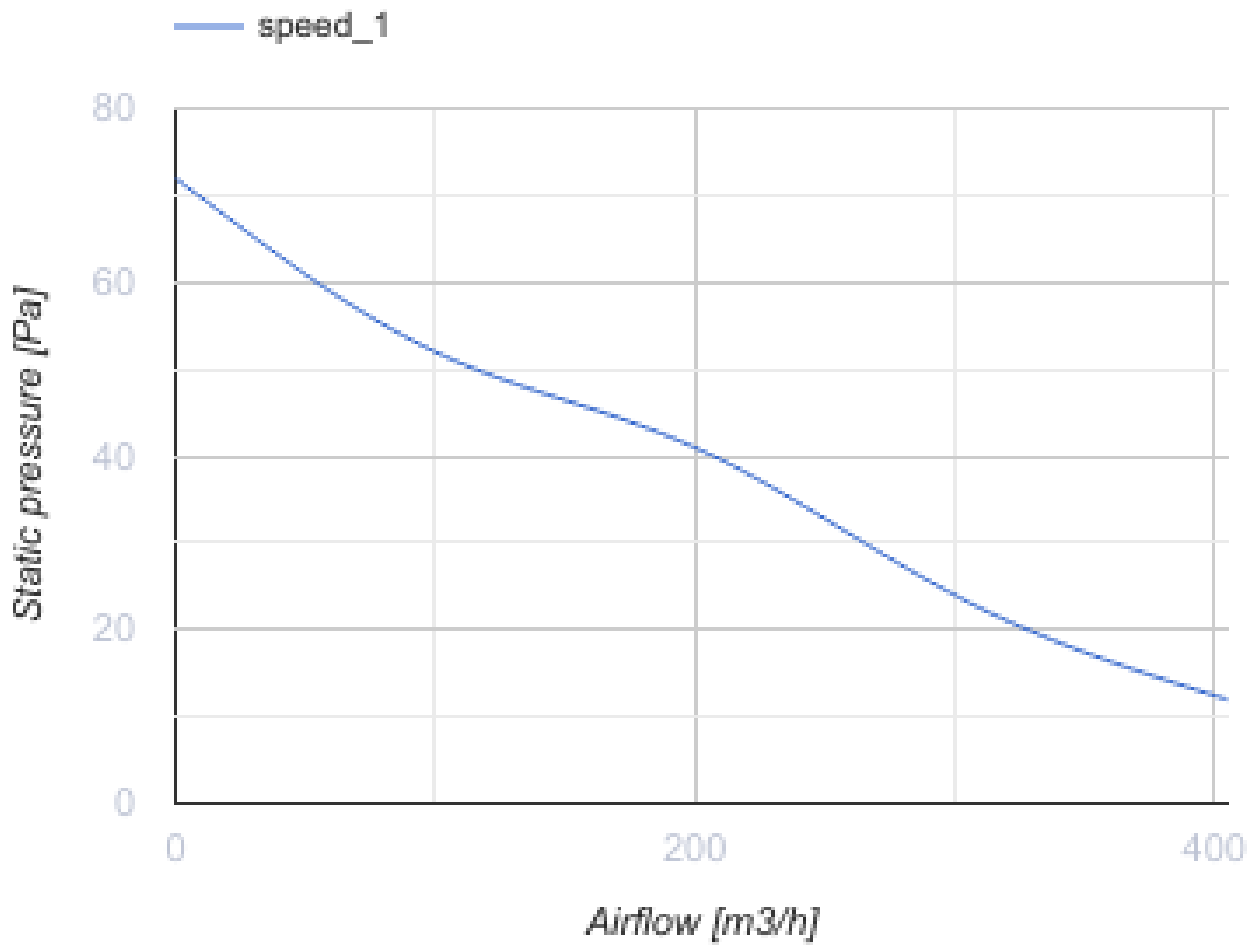

Dimensions

ØD	ØD1	ØD2	Ød	L
208	270	300	7	120

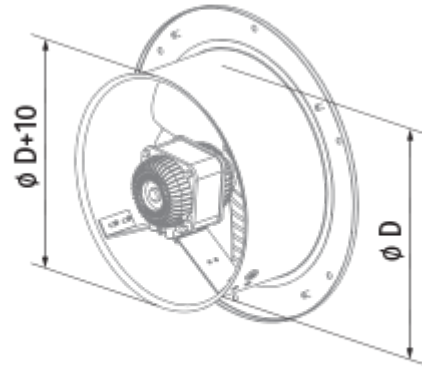
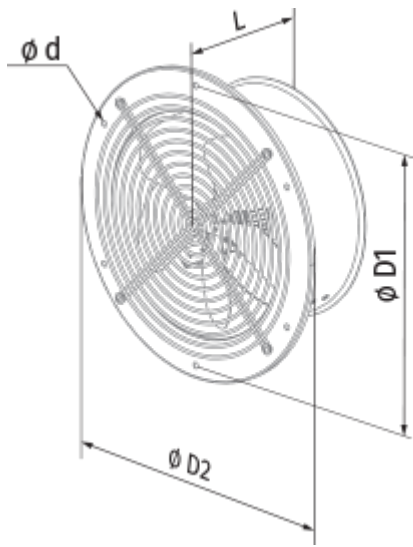

Ecodesign

Trademark	Blauberg
Model	Axis-QRA 200
Type of drive installed	External MSD or VSD
Type of heat recovery system	None
Nominal flow rate (m ³ /s)	0.055
Nominal external pressure (Pa)	42
Maximum external leakage rates (%)	2.7
Static efficiency (%)	8.6
Effective electric power input (kW)	0.027
Sound power level (dB(A))	52
Declared typology	NRVU UVU

Accessories

Thyristor speed controllers

Name	Photo	Description
CDT E1.8		Thyristor speed controller