



Axis-QR 550 4E

Wall-mounted axial fans

- Maximum airflow: 8800
- Sound pressure level LpA at 3 m: 62
- Motor type: AC
- Impeller type: Axial
- Casing material: Coated steel
- Installation in any position

| | Unit of measurement | Axis-QR 550 4E |
|-----------------------------------|---------------------|----------------|
| Connected air duct size | mm | 550 |
| Speed | - | 1 |
| Minimum supply voltage | V | 220 |
| Maximum supply voltage | V | 240 |
| Power supply frequency | Hz | 50/60 |
| Rated power | W | 550 |
| Unit current | A | 2.55 |
| Maximum airflow | m ³ /h | 8800 |
| Sound pressure level LpA at 3 m | dB(A) | 62 |
| Weight | kg | 16.5 |
| Transported air temperature (max) | °C | 60 |
| Transported air temperature (min) | °C | -30 |
| Ingress protection rating | - | IP24 |

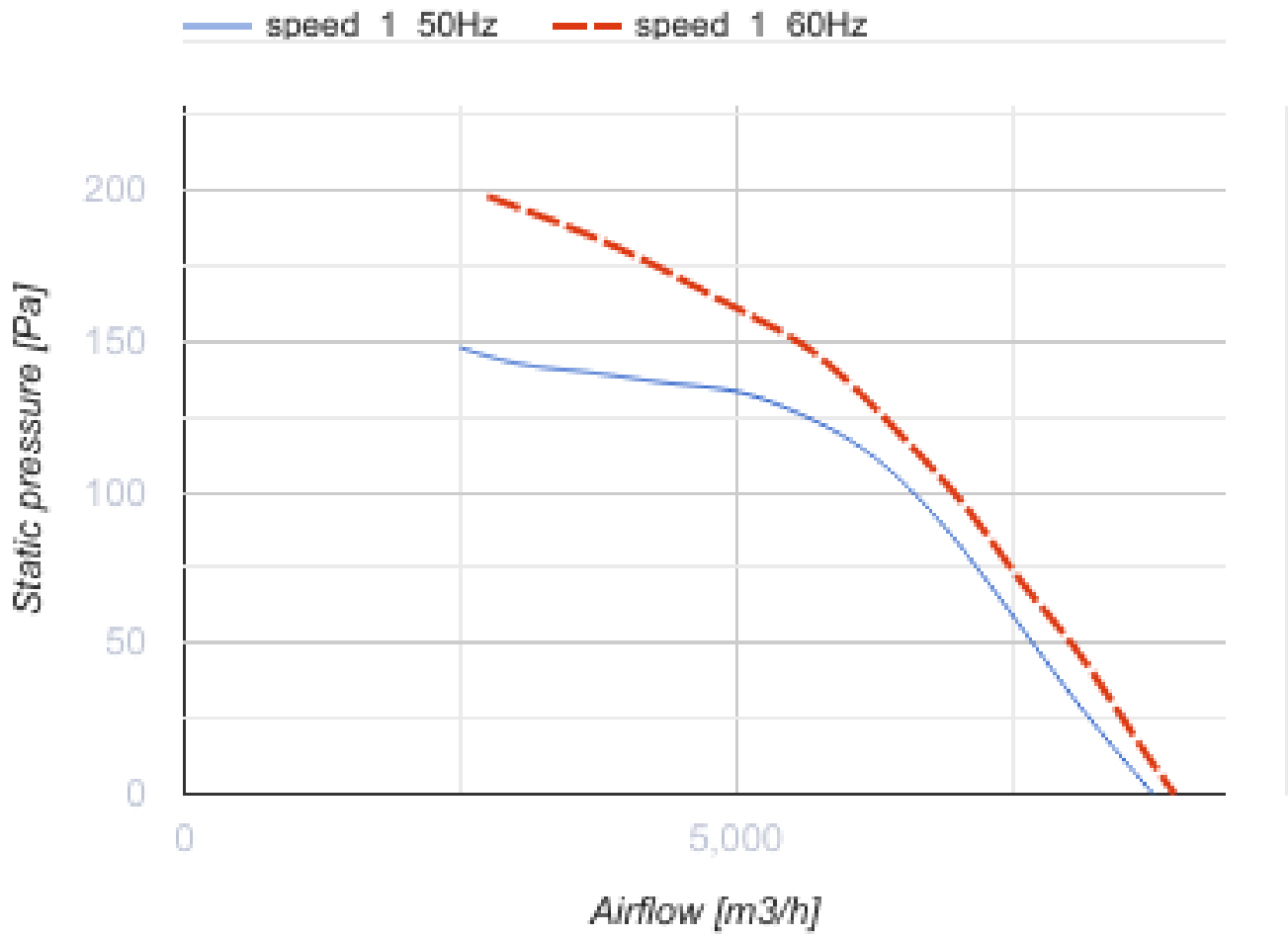

Dimensions

| ØD | ØD1 | ØD2 | Ød | L |
|-----|-----|-----|----|-----|
| 570 | 645 | 710 | 11 | 260 |



Ecodesign

| | |
|---------------------------------------|---------------------|
| Trademark | Blauberg |
| Model | Axis-QR 550 4E |
| Type of drive installed | External MSD or VSD |
| Type of heat recovery system | None |
| Nominal flow rate (m ³ /s) | 1.644 |
| Nominal external pressure (Pa) | 120 |
| Maximum external leakage rates (%) | 2.7 |
| Static efficiency (%) | 34.7 |
| Effective electric power input (kW) | 0.581 |
| Sound power level (dB(A)) | 90 |
| Declared typology | NRVU UVU |

Accessories

Other accessories

| Name | Photo | Description |
|--------------------------|---|----------------------------|
| CDT E1.8 |  | Thyristor speed controller |