

Axis-QR 500 4D

Axial wall fans

- Maximum airflow: 6570
- Sound pressure level LpA at 3 m: 60
- Motor type: AC
- Impeller type: Axial
- Casing material: Coated steel
- Installation in any position

	Unit of measurement	Axis-QR 500 4D
Connected air duct size	mm	500
Speed	-	1
Minimum supply voltage	V	400
Maximum supply voltage	V	400
Power supply frequency	Hz	50/60
Rated power	W	450
Unit current	A	0.9
Maximum airflow	m ³ /h	6570
Sound pressure level LpA at 3 m	dB(A)	60
Weight	kg	14
Transported air temperature (max)	°C	60
Transported air temperature (min)	°C	-30
Ingress protection rating	-	IP24

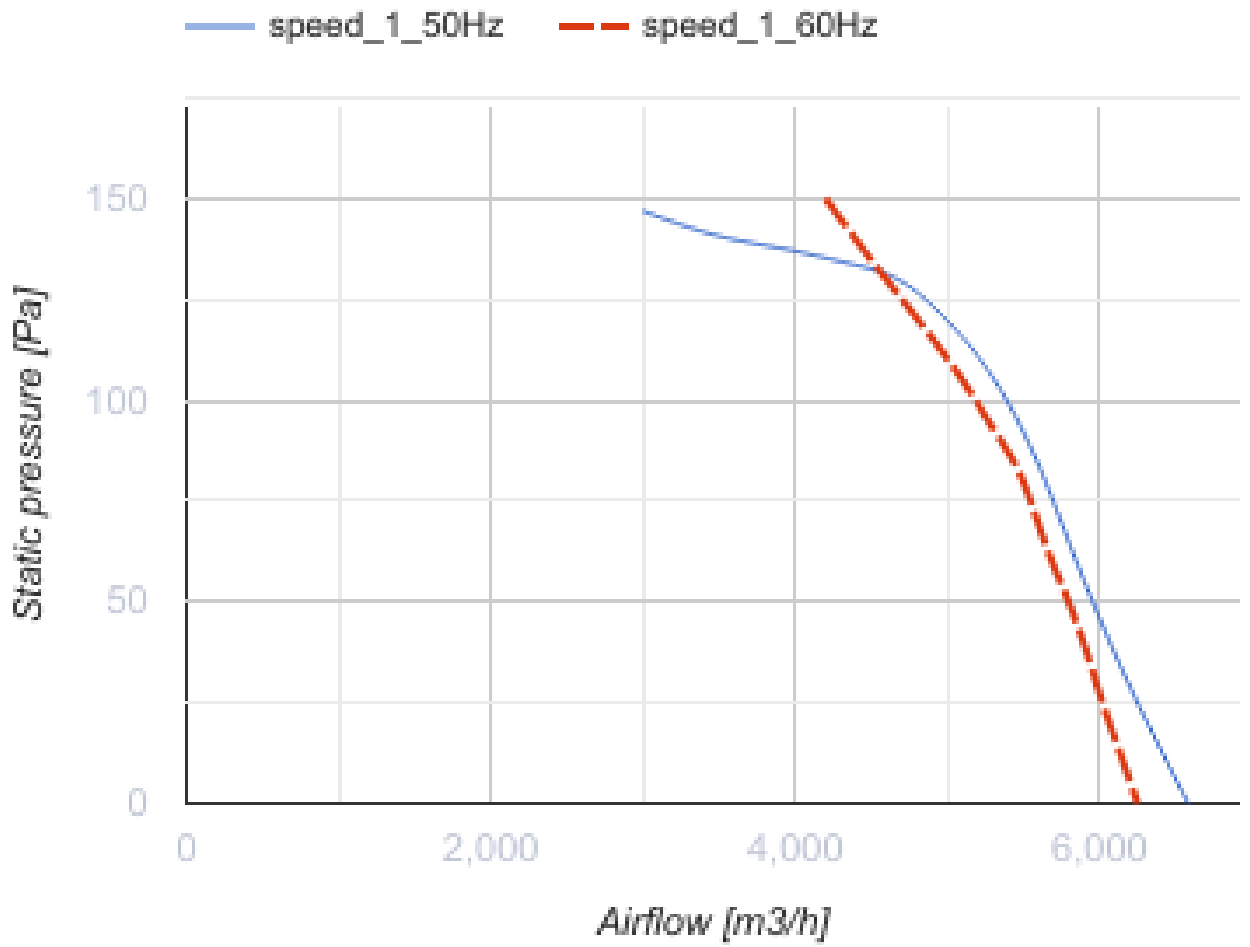

Dimensions

ØD	ØD1	ØD2	Ød	L
520	590	665	11	250

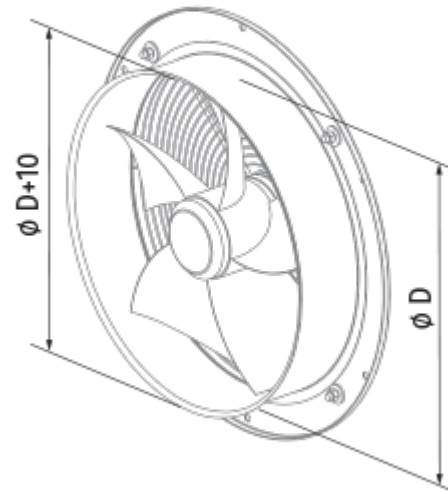
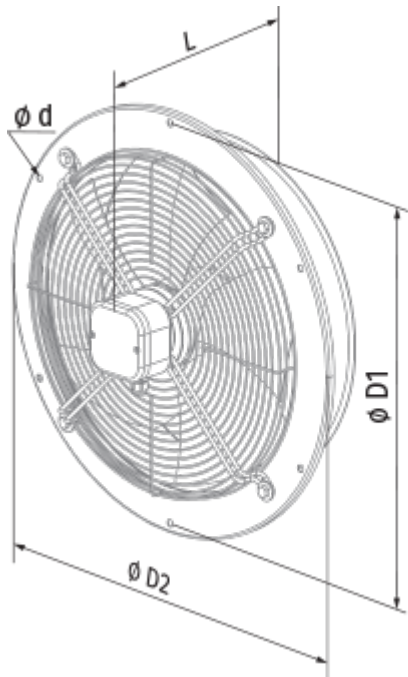

Ecodesign

Trademark	Blauberg
Model	Axis-QR 500 4D
Type of drive installed	External MSD or VSD
Type of heat recovery system	None
Nominal flow rate (m ³ /s)	1.386
Nominal external pressure (Pa)	120
Maximum external leakage rates (%)	2.7
Static efficiency (%)	35.5
Effective electric power input (kW)	0.478
Sound power level (dB(A))	92
Declared typology	NRVU UVU

Accessories

Thyristor speed controllers

Name	Photo	Description
CDT E1.8		Thyristor speed controller