



Axis-QR 400 4E

Axial wall fans

- Maximum airflow: 3580
- Sound pressure level LpA at 3 m: 53
- Motor type: AC
- Impeller type: Axial
- Casing material: Coated steel
- Installation in any position

	Unit of measurement	Axis-QR 400 4E
Connected air duct size	mm	400
Speed	-	1
Minimum supply voltage	V	220
Maximum supply voltage	V	240
Power supply frequency	Hz	50/60
Rated power	W	180
Unit current	A	0.82
Maximum airflow	m ³ /h	3580
Sound pressure level LpA at 3 m	dB(A)	53
Weight	kg	8.5
Transported air temperature (max)	°C	60
Transported air temperature (min)	°C	-30
Ingress protection rating	-	IP24

Dimensions

ØD	ØD1	ØD2	Ød	L
417	504	528	9	220

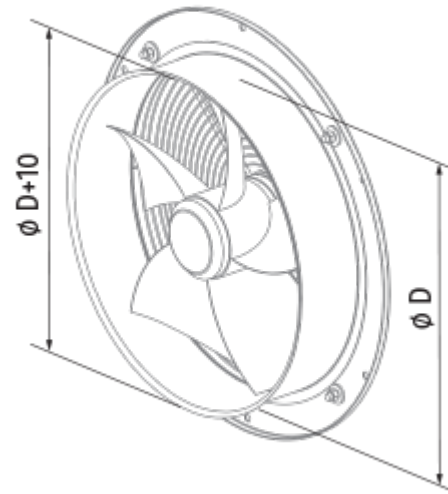
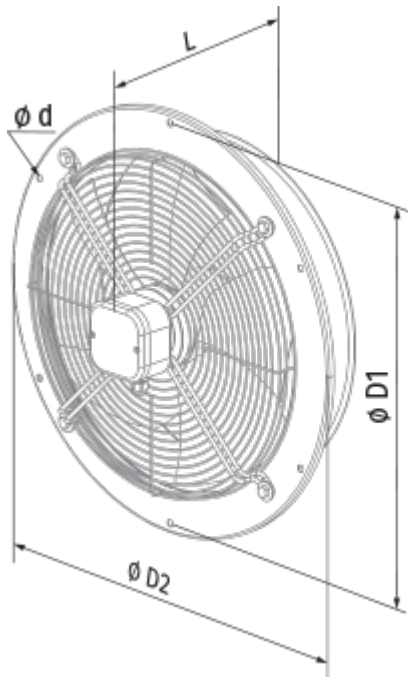

Ecodesign

Trademark	Blauberg
Model	Axis-QR 400 4E
Type of drive installed	External MSD or VSD
Type of heat recovery system	None
Nominal flow rate (m ³ /s)	0.774
Nominal external pressure (Pa)	80
Maximum external leakage rates (%)	2.7
Static efficiency (%)	33.8
Effective electric power input (kW)	0.187
Sound power level (dB(A))	83
Declared typology	NRVU UVU

Accessories

Thyristor speed controllers

Name	Photo	Description
CDT E1.8		Thyristor speed controller