



## Axis-Q 630 4D

Axial wall fans

- Maximum airflow: 12200
- Sound pressure level LpA at 3 m: 69
- Motor type: AC
- Impeller type: Axial
- Casing material: Coated steel
- Installation in any position

	Unit of measurement	Axis-Q 630 4D
Connected air duct size	mm	630
Speed	-	1
Minimum supply voltage	V	400
Maximum supply voltage	V	400
Power supply frequency	Hz	50/60
Rated power	W	800
Unit current	A	1.6
Maximum airflow	m <sup>3</sup> /h	12200
Sound pressure level LpA at 3 m	dB(A)	69
Weight	kg	20
Transported air temperature (max)	°C	60
Transported air temperature (min)	°C	-30
Ingress protection rating	-	IP24

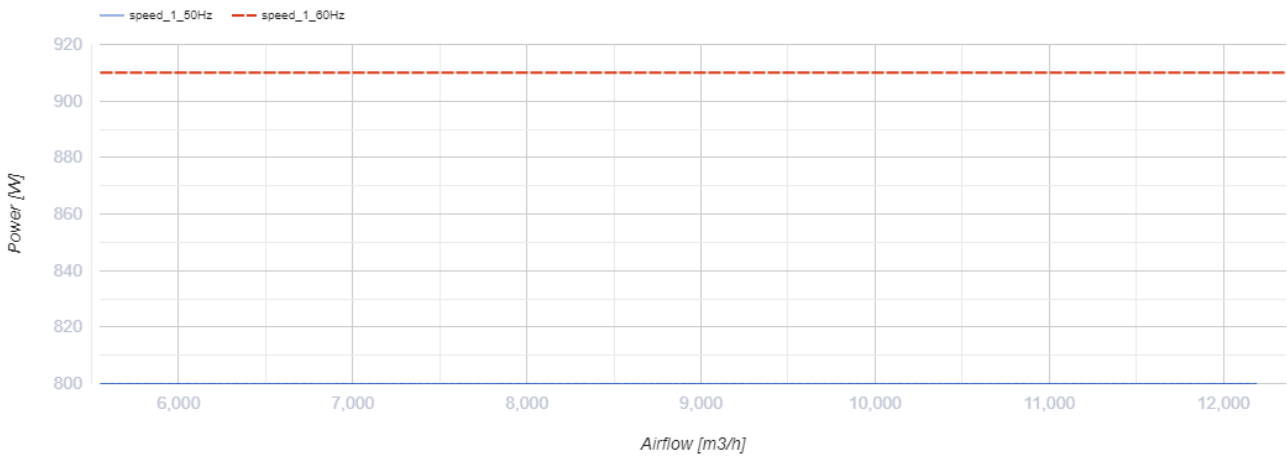
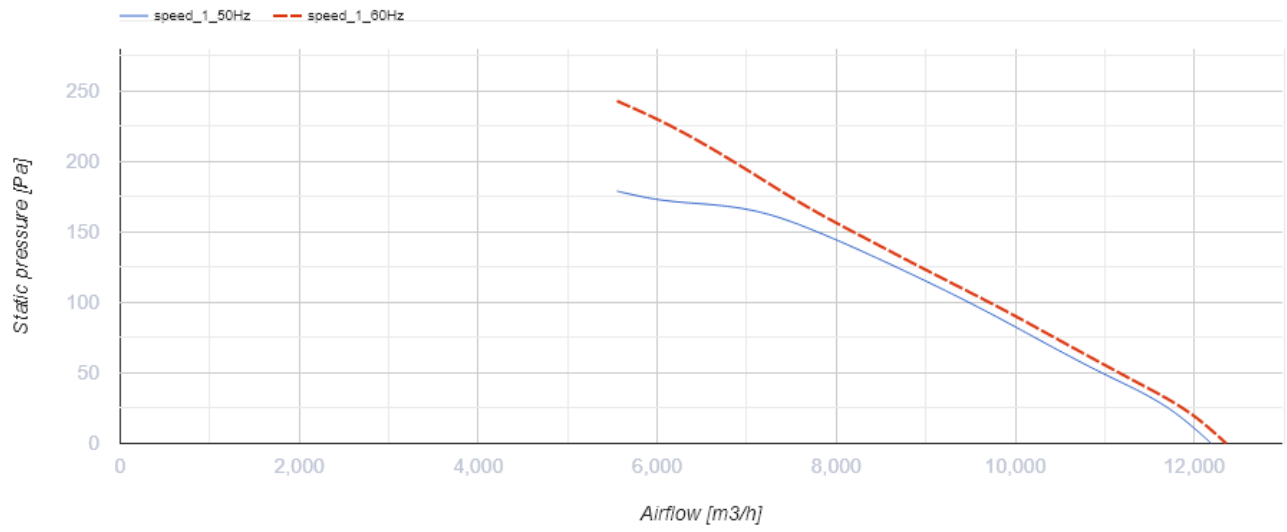

## Dimensions

ØD	Ød	B	B1	L
650	11	800	710	275

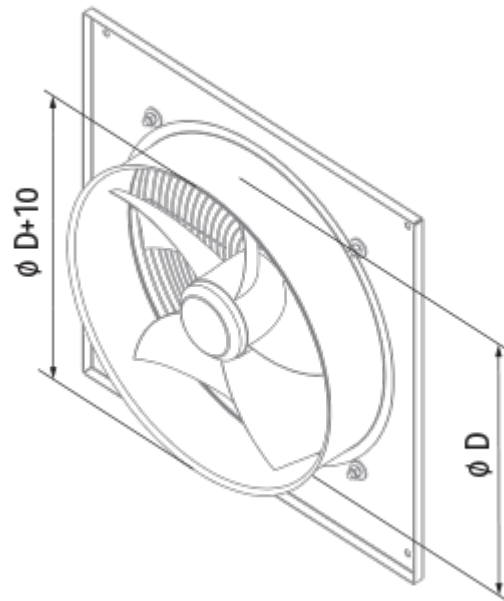
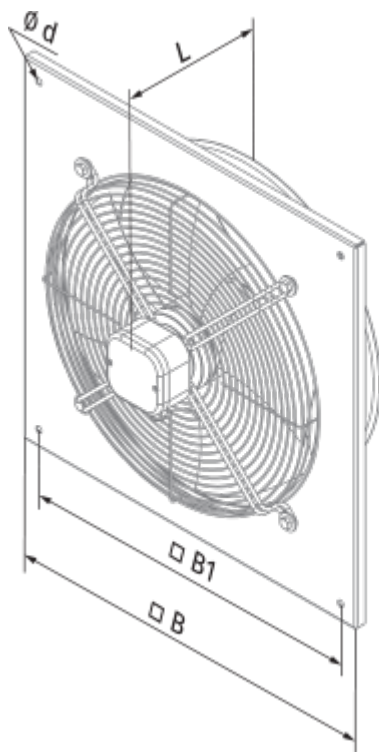

## Ecodesign

Trademark	Blauberg
Model	Axis-Q 630 4D
Type of drive installed	External MSD or VSD
Type of heat recovery system	None
Nominal flow rate (m <sup>3</sup> /s)	2.151
Nominal external pressure (Pa)	152
Maximum external leakage rates (%)	2.7
Static efficiency (%)	41.2
Effective electric power input (kW)	0.81
Sound power level (dB(A))	98
Declared typology	NRVU UVU

## Accessories

### Other accessories

Name	Photo	Description
<a href="#">CDT E1.8</a>		Thyristor speed controller