



Axis-Q 550 4D

Axial wall fans

- Maximum airflow: 9700
- Sound pressure level LpA at 3 m: 64
- Motor type: AC
- Impeller type: Axial
- Casing material: Coated steel
- Installation in any position

	Unit of measurement	Axis-Q 550 4D
Connected air duct size	mm	550
Speed	-	1
Minimum supply voltage	V	400
Maximum supply voltage	V	400
Power supply frequency	Hz	50/60
Rated power	W	750
Unit current	A	1.5
Maximum airflow	m ³ /h	9700
Sound pressure level LpA at 3 m	dB(A)	64
Weight	kg	16.5
Transported air temperature (max)	°C	60
Transported air temperature (min)	°C	-30
Ingress protection rating	-	IP24

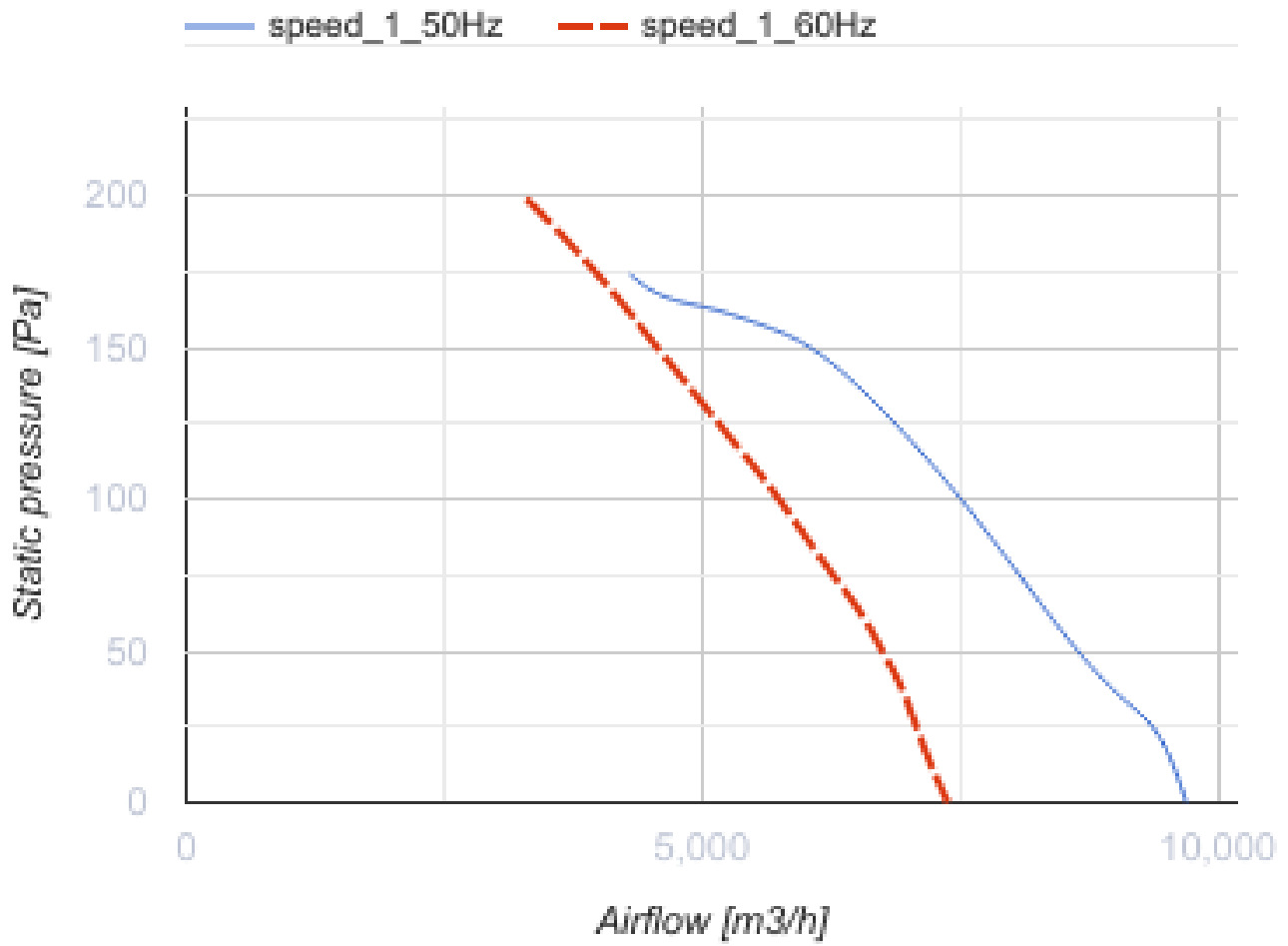

Dimensions

ØD	Ød	B	B1	L
570	11	725	675	260



Ecodesign

Trademark	Blauberg
Model	Axis-Q 550 4D
Type of drive installed	External MSD or VSD
Type of heat recovery system	None
Nominal flow rate (m ³ /s)	1.778
Nominal external pressure (Pa)	140
Maximum external leakage rates (%)	2.7
Static efficiency (%)	38.7
Effective electric power input (kW)	0.656
Sound power level (dB(A))	93
Declared typology	NRVU UVU

Accessories

Other accessories

Name	Photo	Description
CDT E1.8		Thyristor speed controller