

Axis-Q 200 2E

Wall-mounted axial fans

- Sound pressure level LpA at 3 m: 48
- Impeller type: Axial
- Casing material: Coated steel
- Installation in any position

	Unit of measurement	Axis-Q 200 2E	
Connected air duct size	mm	200	
Phases	-	1	
Minimum supply voltage	V	220	
Maximum supply voltage	V	240	
Power supply frequency	Hz	50	60
Rated power	W	55	
Unit current	A	0.26	
Maximum airflow	m ³ /h	860	
Rotation speed at 50hz	-	2300	
Sound pressure level LpA at 3 m	dB(A)	48	
Weight	kg	3	
Transported air temperature (max)	°C	60	
Transported air temperature (min)	°C	-30	
Ingress protection rating	-	IP24	
Ingress protection rating of the drive	-	IP54	
Impeller material	-	Coated steel	
Article	-	8013126	

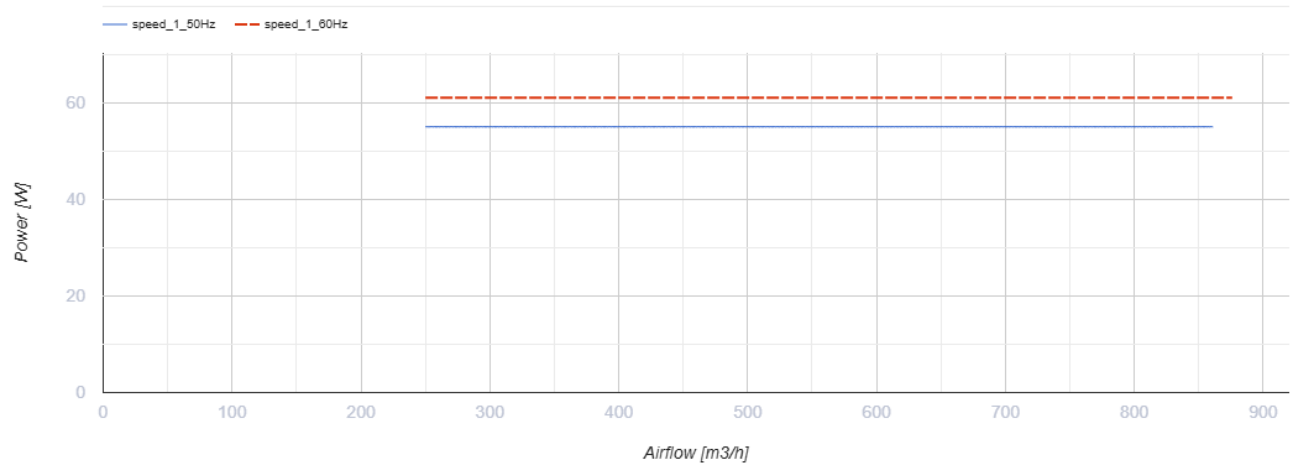
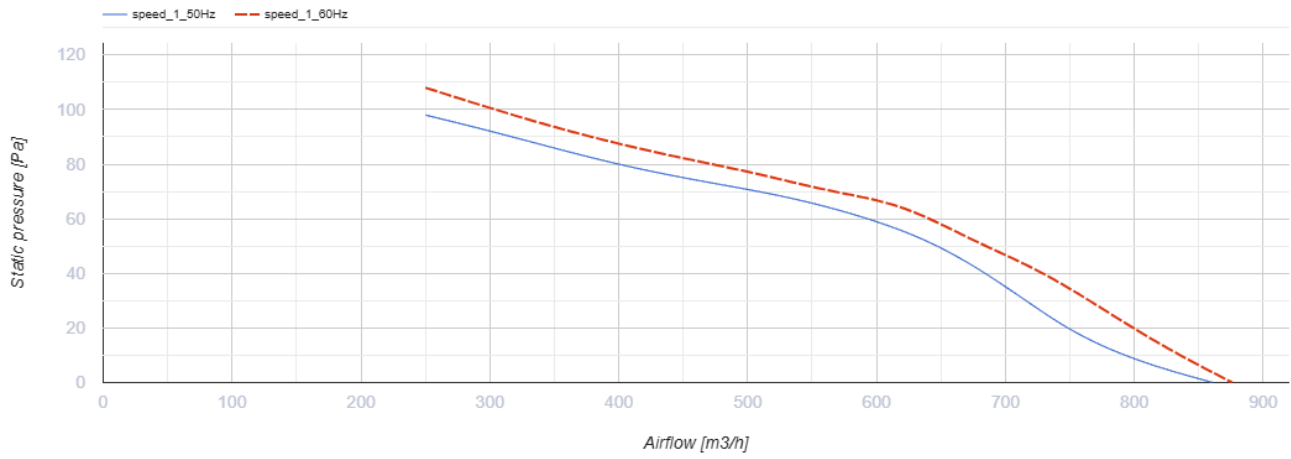

Dimensions

ØD	Ød	B	B1	L
210	7	312	260	125

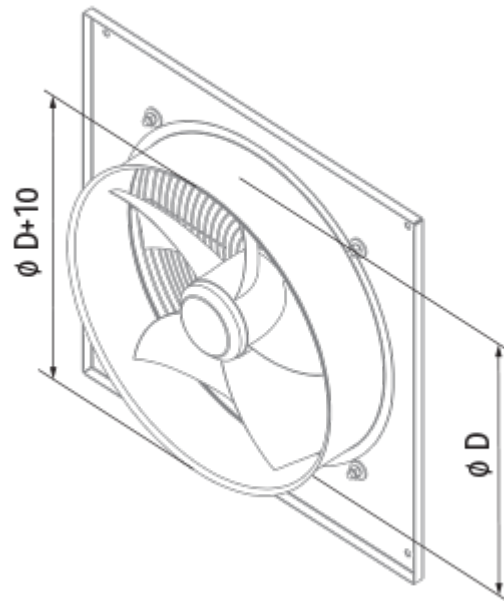
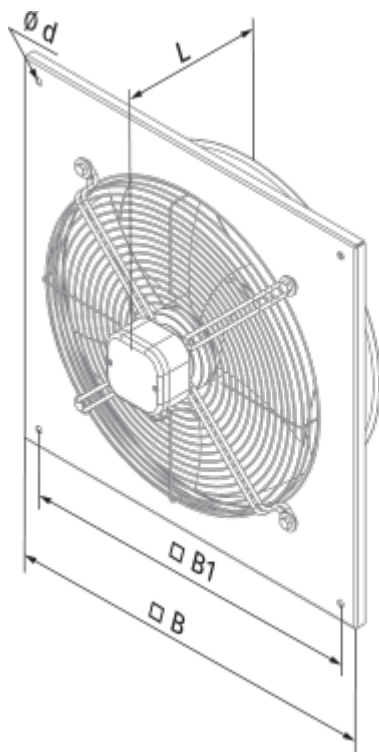

Ecodesign

Trademark	Blauberg
Model	Axis-Q 200 2E
Type of drive installed	External MSD or VSD
Type of heat recovery system	None
Nominal external pressure (Pa)	65
Maximum external leakage rates (%)	2.7
Static efficiency (%)	8.3
Declared typology	NRVU UVU
Effective electric power input (kW)	0.06
Sound power level (dB(A))	70