



## Axis-F 550 4D

Axial inline fans

- Maximum airflow: 9700
- Sound pressure level LpA at 3 m: 64
- Motor type: AC
- Impeller type: Axial
- Casing material: Coated steel
- Installation in any position

	Unit of measurement	Axis-F 550 4D
Connected air duct size	mm	550
Speed	-	1
Minimum supply voltage	V	400
Maximum supply voltage	V	400
Power supply frequency	Hz	50/60
Rated power	W	750
Unit current	A	1.5
Maximum airflow	m <sup>3</sup> /h	9700
Sound pressure level LpA at 3 m	dB(A)	64
Weight	kg	13.9
Transported air temperature (max)	°C	60
Transported air temperature (min)	°C	-30
Ingress protection rating	-	IPX4

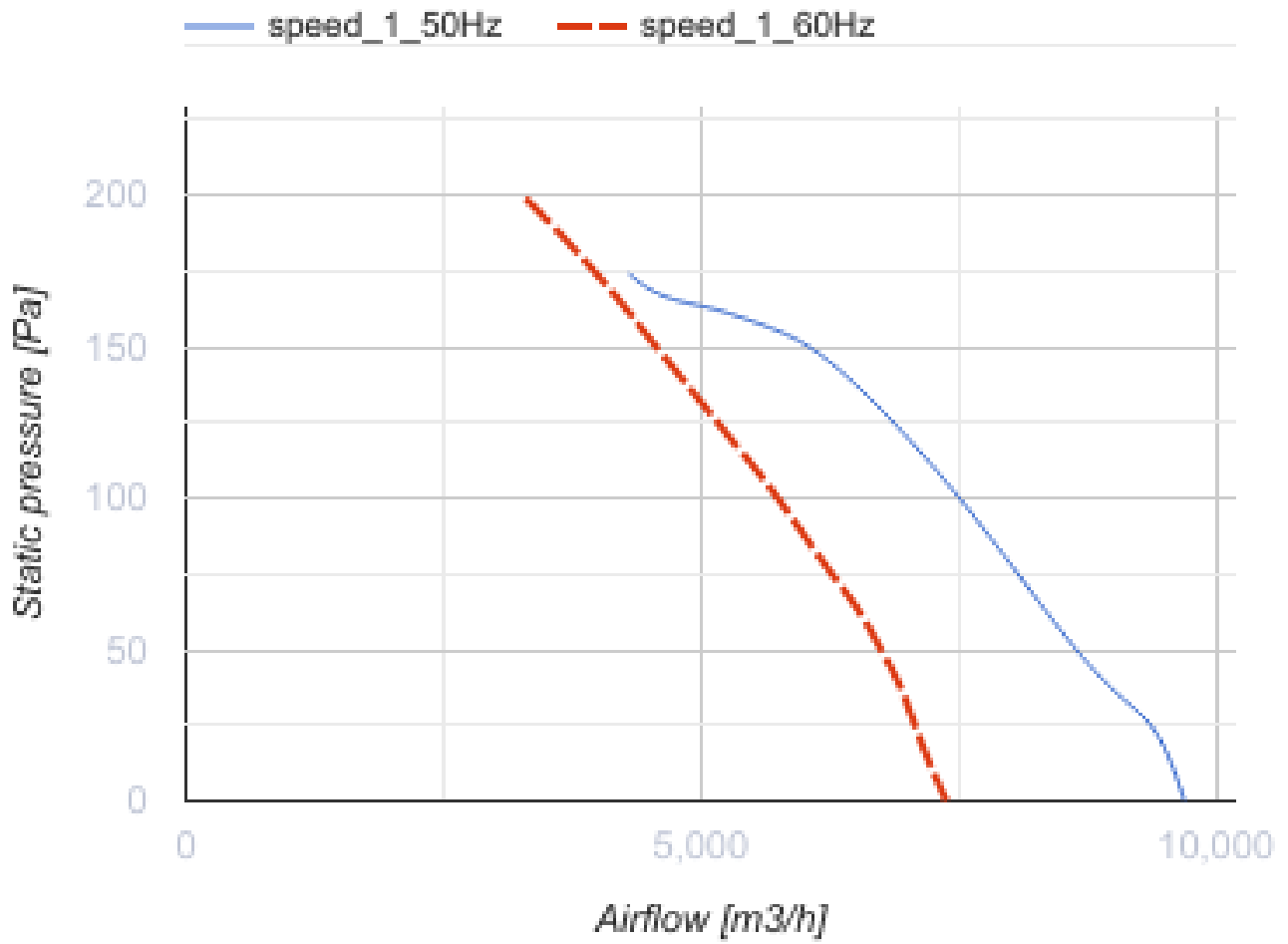

### Dimensions

ØD	ØD1	ØD2	Ød	B	L
565	605	636	11,5	660	230

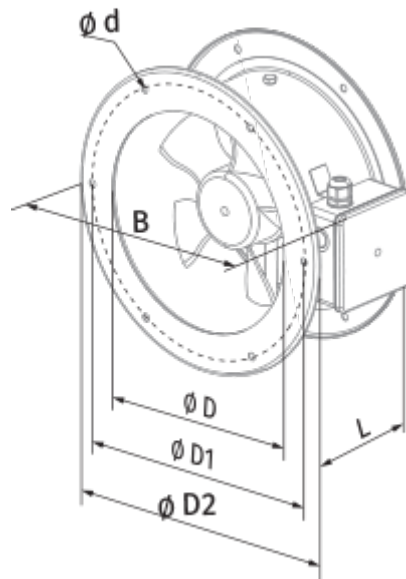

## Accessories

### Thyristor speed controllers

Name	Photo	Description
<a href="#">CDT E1.8</a>		Thyristor speed controller